

My kitchen



nolte[®]
KÜCHEN

MY KITCHEN PROFILE

EVA BRENNER,
NOLTE KÜCHEN
BRAND AMBASSADOR

Together with Eva Brenner, we are pursuing a key goal: to plan the kitchen as the focal point of your home and create solutions that meet your specific wishes, needs and available budget.

LIVING IN THE KITCHEN.



HELP ON DECIDING HOW TO PLAN YOUR VERY OWN KITCHEN

When it comes to planning your new kitchen, you will need to make about 1,000 decisions. We at Nolte Küchen want to simplify the process of arriving at a result that reflects you as a person. With our help, you can create a detailed profile of your preferences and needs that fits your personal lifestyle and home situation. To make this quick and easy for you, we have put together a number of key questions on the next few pages that take a close look at all aspects of life in and with your kitchen. As you answer them, you will also quickly realise all of the options we can give you. And creating your kitchen profile is fun too – it really is. **Look forward to a journey through the world of Nolte Küchen!**

nolte[®]
KÜCHEN



Refer to the check-list on the fold-out page:

The questions on the following pages are arranged by subject matter. These are designed to give you inspiration for your ideas. At the end of this document you will also find a list of potential answers to the questions asked, which the practical fold-out pages let you refer to whenever you wish while you are reading.



We regularly offer webinars on planning kitchens. Get details on our social media channels and subscribe to our newsletter at: newsletter.nolte-kuechen.com



PLANNING WITH EMOTION AND REASON

You can answer all of the questions in the order they are in or in any sequence you choose. Sometimes it may help to browse a little and do some reading first before you decide on an answer. Or take a look at the kitchen you already have, and get an idea of what you really want. You'll very soon be rewarded for all of the thought you put in: once your kitchen profile is ready, the recommendations tailored to you personally are just a step away from your nearest Nolte Küchen retailer.

Take a little time, grab a pen, be guided through the questions and simply tick the appropriate answers in the check-list provided on the fold-out page at the back.

MY SITUATION



Just the way that's tailored to you.

Are you not planning to move or make any structural alterations? A bespoke Nolte kitchen with corner solutions and units planned from wall to wall makes optimum use of the space you have. Are you wanting to remain flexible because you may be planning to move home or extend your kitchen? In this case, a Nolte kitchen in modular design may be more suitable for you.



PREFERABLY TAILOR-MADE – OR RATHER MODULAR AND EXTENDIBLE?

The first home of your own? A newly built home for the family? Preparing for relaxed retirement? Every phase and situation in life comes with its particular needs. And offers different perspectives for the future. Nolte kitchens are geared towards this from the outset – which means they always simply remain part of your life.



- 1 What situation are you living in?
- 2 Do you think you are likely to move and take your kitchen with you in the next 5 years?
- 3 Do you want your kitchen to be a place to work or live in?

Use the check-list in the back cover to answer these questions.



See here our image film *“Living in the kitchen”*

Your lifestyle matters.

Whether for a single person, a couple or a family, your Nolte kitchen is matched exactly to suit any particular situation in life which means it gives you plenty of scope to accommodate your personal work-life balance.



WHO DO I WANT TO SHARE MY KITCHEN WITH?

More and more, the kitchen is becoming the hub of the home. This is why some kitchens need a good measure of flexibility – and others plenty of space to play about with, quite literally. Think about who will be filling your kitchen with life today and in the future. And you can be sure that Nolte Küchen will make everyone feel at home in it.



- 4 How many persons will be using your kitchen?
- 5 How often do you cook?
- 6 What is your style of cooking?



MY STYLE



My personality. My kitchen.

As diverse and individual as people are, so too are the wishes they have when it comes to furnishing their home. This is where their tastes range from trendy urban or timeless classic look to the warm and inviting country-style kitchen. Making the kitchen just as individual as the rest of the home.

You will also find further examples of how to design a kitchen on our website.

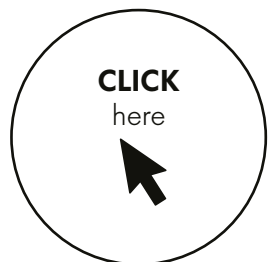

DESIGN STYLES FOR YOUR KITCHEN

Talking about tastes and wishes is a wonderful way of sketching out a more precise picture of the ideas you have. But don't be swayed too much by other people's opinions. Because whatever you like is allowed.



- 7 Which type of environment and style do you feel at home in?
- 8 Which words best describe your taste in kitchens?





MATRIXART

by nolte KÜCHEN

GOOD PLANNING, ALL FROM GOOD ADVICE

MatrixArt is the handleless kitchen for admirers of good design and graphic style. This is where practical functionality meets modern design in an ideal symbiosis. But given the many different options, planning a kitchen like this is extremely challenging. Depending on what you like and goes best with the kitchen you are planning, for instance, you can choose horizontal or vertical lines for tall units and appliance housings. Get advice from a specialist kitchen retailer to make looks and functionality reflect your wishes in every detail – and, step by step, discover the many different design options for yourself.



Kitchen or a place to live in? Why not simply both: MatrixArt's handleless design gives the kitchen a graphic, sleek look.



Great effect: Nolte Küchen provides the option of adding LED lighting not only to the horizontal finger pulls but to vertical ones as well.

MATRIXART 900

by nolte KÜCHEN

DESIGN MEETS STORAGE SPACE

Offering a maximum amount of storage space, the designer carcass is also available as a handleless option with MatrixArt900. The very shallow plinth in conjunction with the 90 cm carcass height and the integrated finger pulls not only provide an ideal working height and plenty of storage space but also create a totally new kitchen look.





HANDLE OR NO HANDLE – THAT IS THE QUESTION

Classic kitchen designs can be accentuated with a wide choice of handles to create intentional effects. With its sleek lines, a handleless kitchen, by contrast, leaves a very modern impression and embraces an understated style. Choose between design with delicate details or purist fronts with a clean-cut look.



9 Handle or no handle?

10 Which style-defining elements do you see in your kitchen?



LIGHTING IS MOOD AND ATMOSPHERE

Light is much more than illumination. Because individually tailored to your kitchen, the lighting concept creates atmosphere, adds statements, plays a key part in defining the feel of the room and personal well-being. Modern LED technology provides pleasantly gentle and versatile lighting you can always match to your personal mood and time of day by remote control. This is an easy way of making more of light – and letting light make more of your kitchen.



The light strip provides better work surface illumination and creates an inviting ambience.

Lighting recessed into the sides do much to enhance base and tall units.





The illuminated MatrixArt finger pull creates a special ambience and underscores the kitchen's lines with tasteful and stunning effect. The integrated wall-unit lighting conjures a warm and inviting ambience.

The right worktop illumination is absolutely essential for the kitchen, but creating individually tailored lighting moods is becoming increasingly important too. Our product line-up features a huge choice in this department too.



MY BUDGET

ALL SORTS OF DIFFERENT SURFACE FINISHES – TO SUIT YOUR PERSONAL TASTE AND BUDGET

Genuine or reproduction – hardly distinguishable. Admittedly, both are hard to tell apart because, first and foremost, all of the materials used in a Nolte kitchen are marked by a feel of particular quality. Genuine materials, such as wood, metal, lacquer or cement, are the perfect choice for kitchen fans with exacting expectations.

But high-quality reproductions are also available for many natural products. These absolutely authentic surfaces are in no way inferior to the original and surprise the senses with perfectly imitated texture and colouring. They also meet the wish for individuality and something special in a way that is second to none. The kitchen's outfit is also tailored to your wishes and budget, with our PremiumLINE drawers, for example. Now all you have to do is decide on the option for you.



- 11 Which materials / surface finishes do you prefer?
- 12 What do you want to spend on your new kitchen?

LEGNO Oak champagne

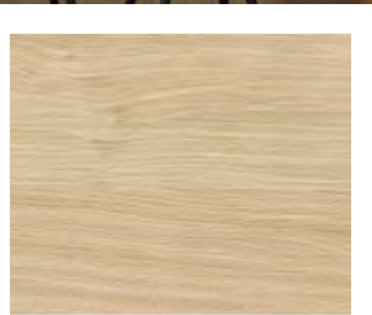

ARTWOOD natural bough oak

WOODEN SURFACE

LEGNO TAVOLA

Real wood for exceptional kitchens

ARTWOOD MANHATTAN

In no way inferior to the original

METAL SURFACE

FERRO

Our real metal front is even magnetic

METAL

An authentic interpretation of the metal theme

CEMENT SURFACE

PORTLAND

Our front with real cement surface

STONE LUCCA

Realistic cement/concrete look with a surprisingly genuine feel

LACQUERED SURFACE

SOFT LACK NOVA LACK FINE LACK

Ranges of genuine lacquer in mat and gloss

FEEL LUX

Lacquered laminate as an impressive alternative

FROM SINGLE GALLEY TO ISLAND – CHOOSE YOUR KITCHEN SHAPE

When planning, you have all the options: whether large or small space, with or without a kitchen island, set across a corner, units opposite one another, against one or more walls – everything is possible with Nolte Küchen. Whichever kitchen you choose, Nolte kitchens can be matched to virtually any wish and produced to meet your every personal preference and need.



Single galley



L-shaped



U-shaped



Single galley + island



Single galley + island + counter



Single galley + island with table solution



SINGLE GALLEY



L-SHAPED



SINGLE GALLEY + ISLAND + COUNTER



SINGLE GALLEY + ISLAND WITH TABLE SOLUTION

WITH PRECISION PLANNING ...

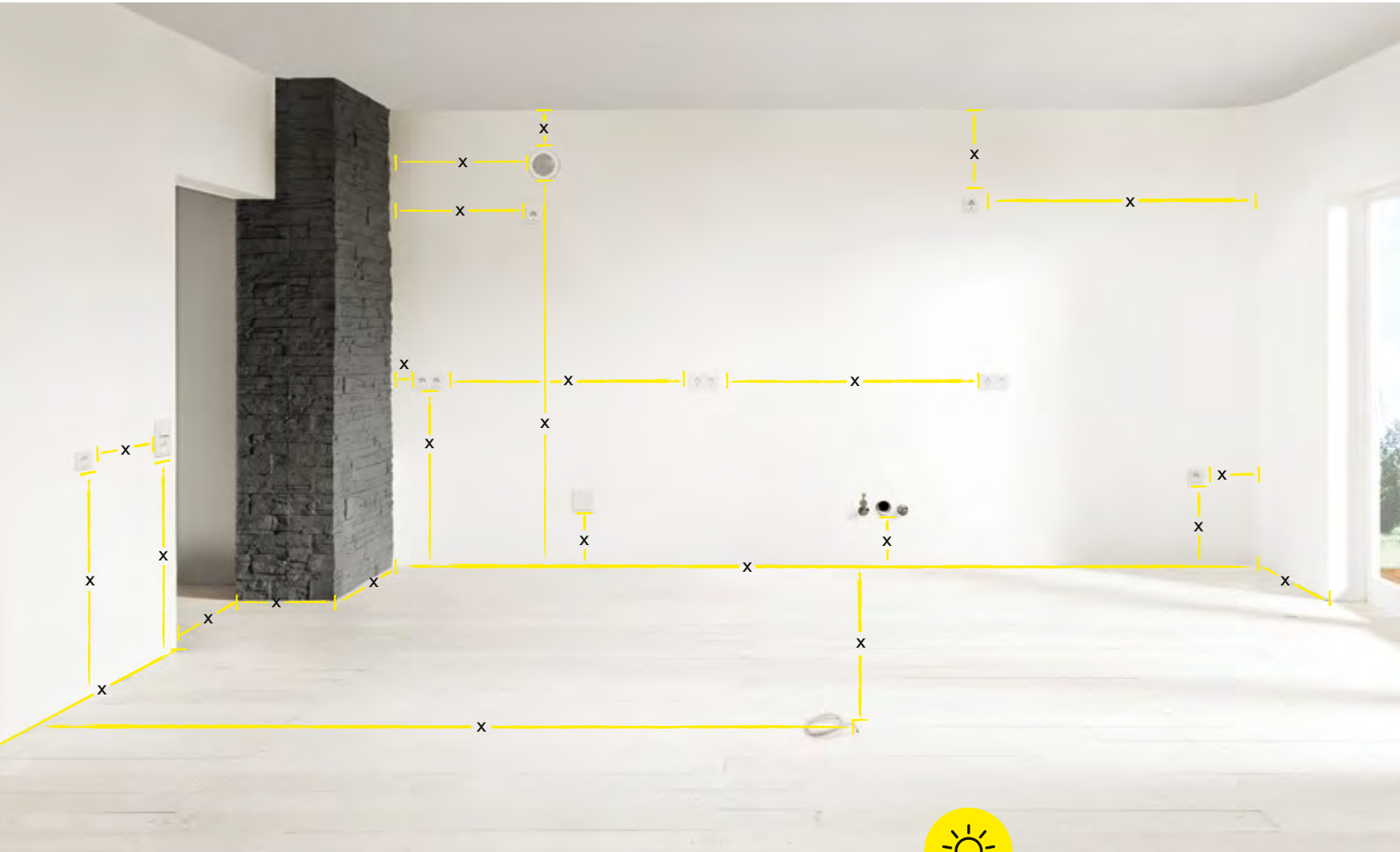

A detailed floor plan is the basis for planning your kitchen. It should also show the exact positions of doors, windows, connections, power sockets, radiators etc. It is also important to document all structural specifics and requirements.

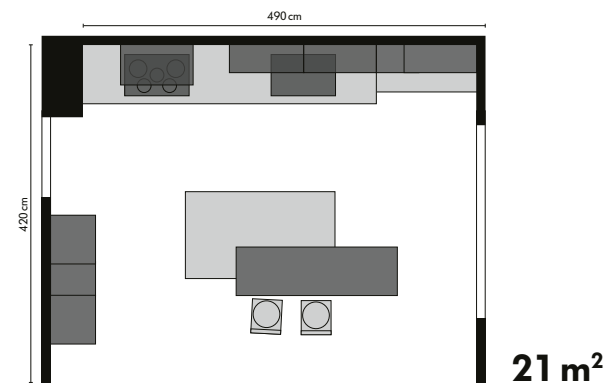

... EFFICIENCY EVERY STEP OF THE WAY

From small rented flat to loft apartment, there's a place for Nolte kitchens everywhere. And all of them make optimum use of the space that's available. But often, the various dimensions and parameters seem to make things clear and, at first sight, leave room for little variation. Simply let your kitchen planner astonish you though, because there's no limit to good and creative planning.



- 13 How much space you have for your kitchen?
- 14 Which particular structural aspects need to be considered in the room?
- 15 Looking for an open or an enclosed kitchen?
- 16 Which kitchen shape do you prefer?

MY NEED FOR STORAGE SPACE

LOGICALLY PLANNED WITH REFINED DETAILS

To begin with, think about what you want to get done in your kitchen and where to keep this, that and the other. This way, you can structure the various zones and coordinate everything. To start planning the kitchen straight away, use our web planner at www.nolte-kuechen.com

Quickly and easily to hand: the larder unit with height-adjustable food storage baskets optimise organisation for kitchen utensils in various sizes.



Pots and pans are kept on pull-outs to save space. They can be opened all the way, giving you direct access to all utensils.

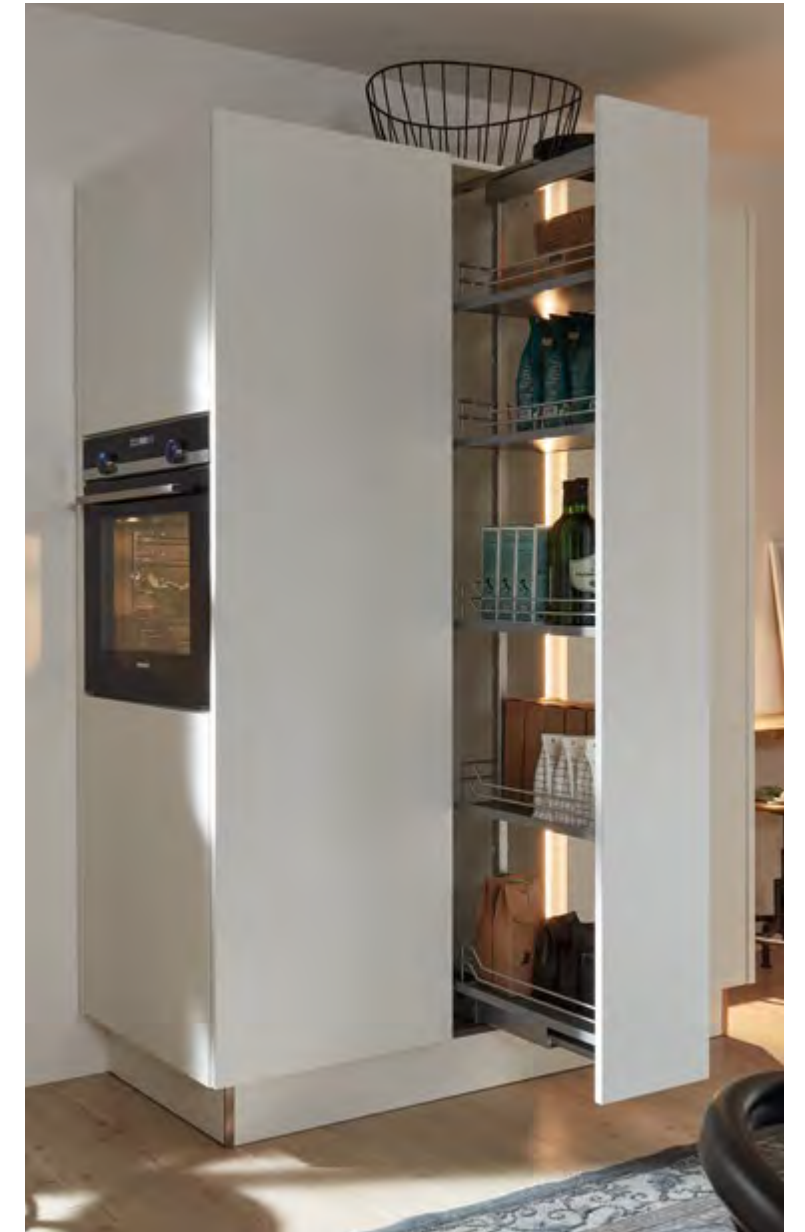

The pull-out larder unit provides a huge amount of storage space. And everything is instantly to hand – from both sides.

MY NEED FOR STORAGE SPACE



+32% MORE STORAGE SPACE

Opening our extra deep pull-outs produces a real 'wow' effect: the 75 cm planning depth gives you an impressive 32 % more storage space – with only 15 cm more space needed at the wall. And they give you considerably more usable space on the worktop in the bargain!



Perfect use is made of corners too – with the "LeMans" corner base unit, for example.



Plenty of storage space: in the pull-out larder unit, everything can be reached from both sides.

THE STORAGE WIZARD IN YOUR NOLTE KITCHEN

In a Nolte kitchen, every inch provides space for your life. Because there's never enough storage space. But there are intelligent solutions that make optimum use of the space that's available in your kitchen. Simply think about all the things to need to store – and how you want to get to them. And your kitchen planner will team up with us and provide the perfect storage space concept.



- 17** How do you normally do your shopping?
- 18** Is any additional storage space available?
- 19** Which kitchen appliances do you need to keep on the worktop or store in a cupboard?

MY NEED FOR STORAGE SPACE

MATRIX 900

by nolte KÜCHEN

20% MORE STORAGE SPACE

Coming in a carcass height of 90 cm, Matrix 900 provides no less than 20% more storage space over the standard 75 cm height shown above. This makes optimum use of available space – particularly in small kitchens.



MATCHED TO YOUR STATURE

Anyone spending a lot of time in the kitchen needs pleasant conditions to work in. This is where it is always a matter of striking the perfect balance between design and practicality. Because we never look at one without considering the other when we plan your Nolte kitchen, you can always be sure: the measure of all things is you. A good feeling that's noticed in every job you do.



- 20** How tall are the persons who regularly use the kitchen?
- 21** Which appliances need to be integrated in a way that makes them ergonomic to use?
- 22** Do you want to lower the worktop to give you more work surface?



Ergonomic perfection

Nolte kitchens let you match working height to how tall you are. While standing, the most comfortable working height is when the distance between worktop and bent elbow is approx. 15 cm. Variable plinth heights, different carcass heights and three worktop thicknesses make it possible to provide an ergonomic working height for persons of any stature.

PLINTH + CARCASE + WORKTOP = ERGONOMIC WORKING HEIGHT

Working height: **92.5 cm**



Working height: **96.2 cm**



EXACTLY WHAT I'M LOOKING FOR

The following collection and product guide clearly lists all details and options for the various elements you wish to include in your Nolte kitchen. This is where your Nolte kitchen adviser will also be pleased to assist you in person.

Matrix 150	Page 34
PremiumLINE	Page 36
Base units	Page 38
Interior organisation	Page 44
Wall units	Page 46
Top-mounted units	Page 48
Larder units and appliance housings	Page 49
Fronts	Page 55
Mat lacquer system	Page 62
Splashback design	Page 64
Handles	Page 66
Carcase decors	Page 70
Worktops	Page 72



PERFECT FOR LIVING IN THE KITCHEN

Carefully balanced lines – easy to configure!

Simple, logical and clear: Matrix150 is a grid system that comes exclusively from Nolte Küchen. It is based on a very simple and easy-to-follow dimensioning logic in which all widths, heights and, in some cases even depths, can be divided by 15 cm.

And the wall-unit depth of 35 cm also provides the perfect place to keep pasta plates. Our grid system also comes with particular benefits when it comes to fitting ovens: the standard 60 cm grid size lets you fit all ovens makes with a precise fit, requiring no filler panel to distract from the look.

Planning versatility for you.

Meeting any specific preference in every room situation, Nolte Küchen has:

- 5 base-unit heights
- 8 wall-unit heights
- 6 tall unit heights
- 4 base unit depths
- 2 wall unit depths
- 3 worktop thicknesses
- Variable plinth heights

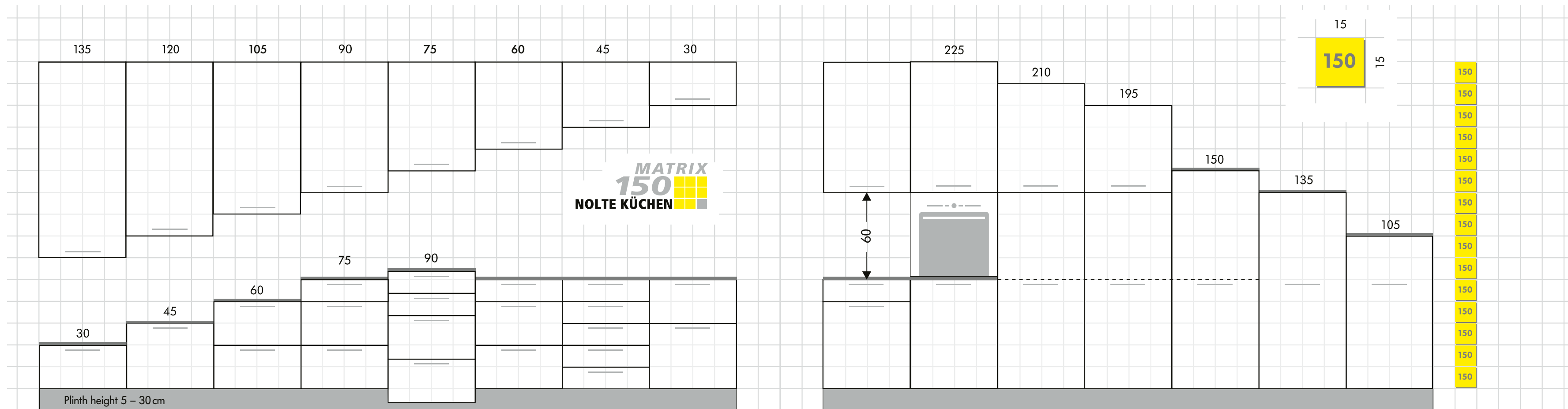

PREMIUMLINE DRAWER



PREMIUMLINE – THE DRAWER SYSTEM IN A CLASS OF ITS OWN



PremiumLINE



PremiumLINE Box



PremiumLINE Glass

Perfect in function and design on the inside too.

The Nolte Küchen PremiumLINE drawer and pull-out system impresses right across the board: the designer-style drawer side profile in stainless steel look harmonises perfectly with the drawer base in quartz grey. With PremiumLINE Box, the high-quality basic configuration gives you even more storage space thanks to the closed side profiles. The range-topping PremiumLINE Glass option combines more space with the best possible view of everything inside through the glass side panel – even in a width of up to 120 cm.

More light – better view!

Interior lighting can be used to show off drawers and pull-outs with stunning effect – and provide an even better view of contents.



BASE UNITS 75 cm

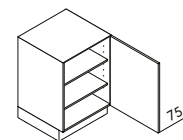
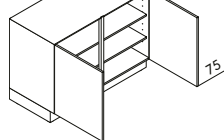
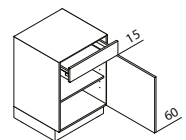
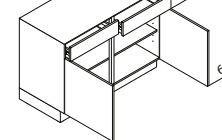
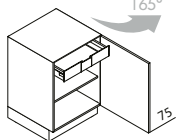
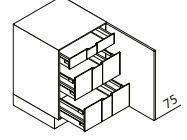
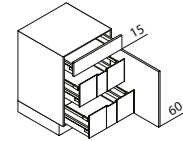
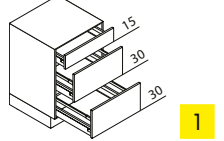
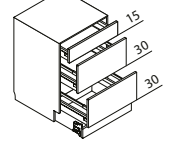
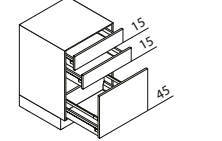
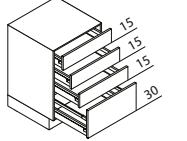
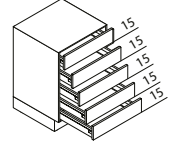
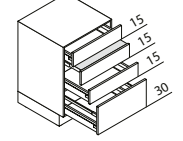
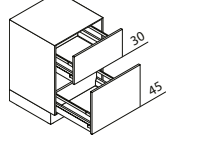
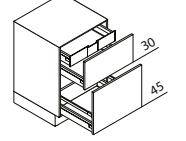
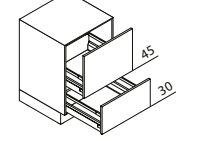
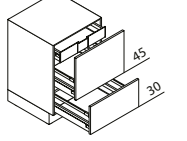
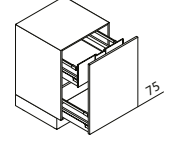
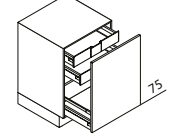
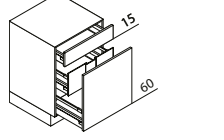
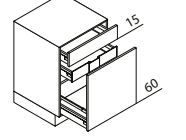
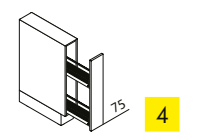
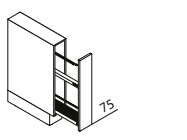
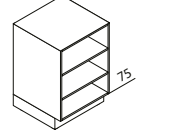
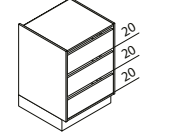

 UDD Base unit ↔ 30/35/40/45/50/60 ↓ 75 ↙ 60/50/39	 UDD Base unit ↔ 80/90/100/120 ↓ 75 ↙ 60/50/39	 U Base unit ↔ 30/40/45/50/60 ↓ 75 ↙ 60/50/39	 U Base unit ↔ 80/90/100/120 ↓ 75 ↙ 60/50/39	 UDDI Base unit ↔ 40/45/50/60 ↓ 75 ↙ 60/50	 UDD Base unit ↔ 40/45/50/60 ↓ 75 ↙ 60/50/39
 UI Base unit ↔ 40/45/50/60 ↓ 75 ↙ 60/50/39	 UAK Pull-out unit ↔ 30/40/45/50/60/80/90/100/120 ↓ 75 ↙ 60/50/75/39	 UAKS Pull-out unit with large-capacity drawer ↔ 60/80/90/100 ↓ 75 ↙ 60	 UAS Drawer base unit ↔ 30/40/45/50/60/80/90/100/120 ↓ 75 ↙ 60/50/75/39	 USA Drawer base unit ↔ 30/40/45/50/60/80/90/100/120 ↓ 75 ↙ 60/50/39	 US Drawer base unit ↔ 30/40/45/50/60/80/90/100/120 ↓ 75 ↙ 60/50
 USAP Drawer base unit with work table ↔ 60 ↓ 75 ↙ 60	 UZ Pull-out unit ↔ 30/40/45/50/60/80/90/100/120 ↓ 75 ↙ 60/50/75/39	 UZI Pull-out unit ↔ 30/40/45/50/60/80/90/100/120 ↓ 75 ↙ 60/50/75/39	 UAZ Pull-out unit ↔ 30/40/45/50/60/80/90/100/120 ↓ 75 ↙ 60/50	 UAZI Pull-out unit ↔ 30/40/45/50/60/80/90/100/120 ↓ 75 ↙ 60/50	 UATDIA Pull-out unit ↔ 30/40/45/50/60 ↓ 75 ↙ 60/50
 UATD Pull-out unit ↔ 30/40/45/50/60 ↓ 75 ↙ 60/50	 UATIA Pull-out unit ↔ 30/40/45/50/60/80/90/100/120 ↓ 75 ↙ 60/50	 UAT Pull-out unit ↔ 30/40/45/50/60/80/90/100/120 ↓ 75 ↙ 60/50	 UKD Stile unit ↔ 15 ↓ 75 ↙ 60	 UKTD Stile unit with towel rail ↔ 15 ↓ 75 ↙ 60	 UR Open shelf base unit ↔ 15/20/25/30/35/40/45/50/55/60 ↓ 75 ↙ 60/39
 URI Base unit shelf with drawers ↔ 60/90 ↓ 75 ↙ 60	<p>↔ Unit width ↓ Unit height ↙ Planning depth</p>				

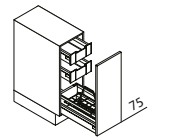
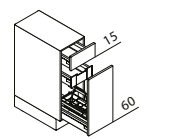
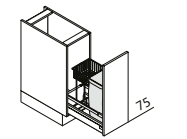
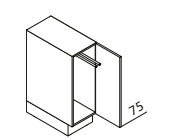
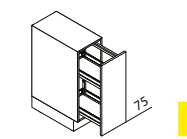
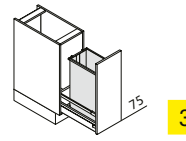
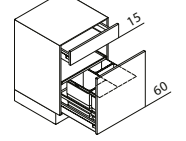
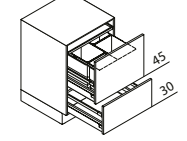
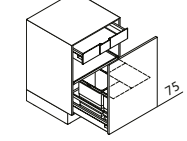

The base units in your Nolte kitchen give you numerous and extremely versatile design options – making sure you get precisely the storage space you need.

 UAIDP Pull-out unit ↔ 30 ↓ 75 ↙ 60	 UAI Pull-out unit ↔ 30 ↓ 75 ↙ 60	 UBD Pull-out unit with baguette and utensils insert ↔ 30 ↓ 75 ↙ 60	 UTD Base unit with towel rails ↔ 30 ↓ 75 ↙ 60	 UVK Pull-out unit with food storage baskets ↔ 30 ↓ 75 ↙ 60
 UWSD Pull-out unit with container for recyclables bag. ↔ 30 ↓ 75 ↙ 60	 UABG Pull-out unit with waste bin ↔ 40/45/50/60 ↓ 75 ↙ 60	 UABO Pull-out unit with waste bin ↔ 30/40/45/50/60 ↓ 75 ↙ 60	 UABDG Pull-out unit with waste bin ↔ 40/45/50/60 ↓ 75 ↙ 60	

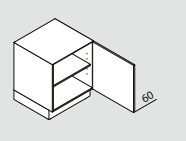
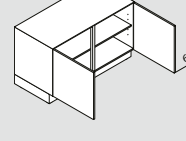
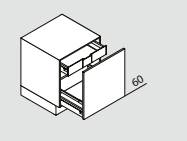
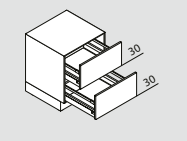
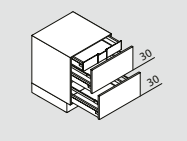
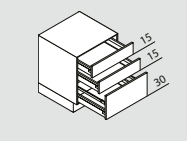
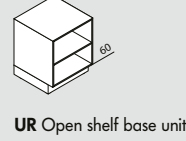
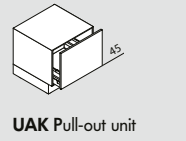
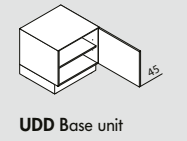
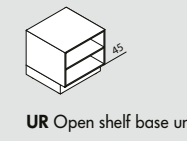
BASE UNITS 60 | 45 | 30 cm

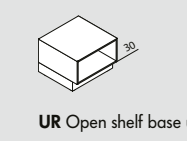
 UDD Base unit ↔ 30/35/40/45/50/60 ↓ 60 ↙ 60/50/39	 UDD Base unit ↔ 80/90/100/120 ↓ 60 ↙ 60/50/39	 UATD Pull-out unit ↔ 30/40/45/50/60/80/90/100 ↓ 60 ↙ 60/50	 UAZ Pull-out unit ↔ 30/40/45/50/60/80/90/100/120 ↓ 60 ↙ 60/50	 UAZI Pull-out unit ↔ 30/40/45/50/60/80/90/100 ↓ 60 ↙ 60/50	 USA Drawer base unit ↔ 30/40/45/50/60/80/90/100 ↓ 60 ↙ 60/50
 UR Open shelf base unit ↔ 30/40/45/50/60 ↓ 60 ↙ 60/39	 UAK Pull-out unit ↔ 30/40/45/50/60/80/90/100/120 ↓ 45 ↙ 60/50/39	 UDD Base unit ↔ 30/40/45/50/60 ↓ 45 ↙ 60/50/39	 UR Open shelf base unit ↔ 30/40/45/50/60 ↓ 45 ↙ 60/39	 UAK Pull-out unit ↔ 30/40/45/50/60/80/90/100/120 ↓ 30 ↙ 60/50/39	 UR Open shelf base unit ↔ 30/40/45/50/60 ↓ 30 ↙ 60/39

BASE UNITS 75 cm

Sink base units

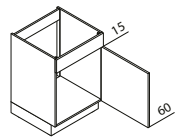

SO Sink base unit

↔ 45/50/60
↓ 75
↙ 60/50

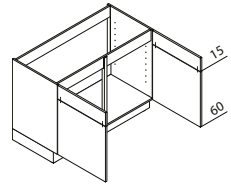

SO Sink base unit

↔ 80/90/100/120
↓ 75
↙ 60/50

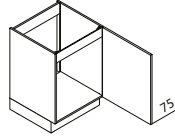

SOD Sink base unit

↔ 45/50/60
↓ 75
↙ 60/50

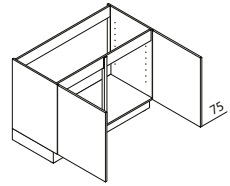

SOD Sink base unit

↔ 80/90/100/120
↓ 75
↙ 60/50

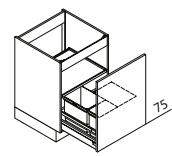

SABD Sink base unit with waste separation system

↔ 45/50/60
↓ 75
↙ 60

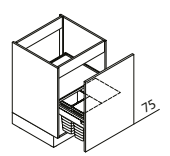

SABHD Sink base unit with side mounted waste separation system

↔ 45/50/60
↓ 75
↙ 60

7

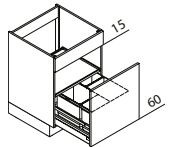

SAB Sink base unit with waste separation system

↔ 45/50/60/80/90/100/120
↓ 75
↙ 60

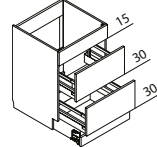

SABS Sink base unit with large-capacity plinth pull-out

↔ 60/80/90/100/120
↓ 75
↙ 60

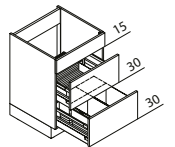

SAKT Sink base unit with waste separation system

↔ 60/80/90/100/120
↓ 75
↙ 60

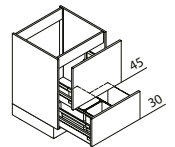

SAZ Sink base unit with waste separation system

↔ 60/80/90/100/120
↓ 75
↙ 60

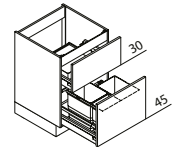

SUZ Sink base unit with waste separation system

↔ 60/80/90/100/120
↓ 75
↙ 60

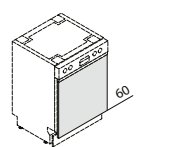

GSB Front panel for integratable dishwasher

↔ 45/60
↓ 75
↙ 60

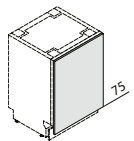

GSBD Front panel for fully integratable dishwashers

↔ 45/60
↓ 75
↙ 60

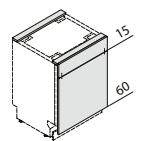

sSBS Front panel for fully integrated dishwashers

↔ 45/60
↓ 75
↙ 60

Corner units

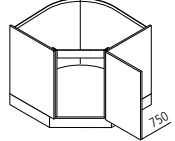

UESD Corner sink base unit

↔ 90
↓ 75
↙ 60

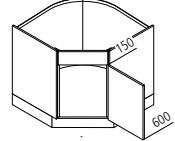

UES Corner sink base unit

↔ 90
↓ 75
↙ 60

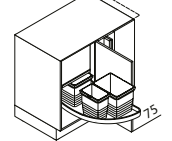

UEPSZ Sink base unit space filler

↔ 110/115/125
↓ 75
↙ 60

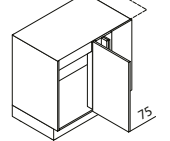

UESAD Sink base unit space filler

↔ 110/115/125
↓ 75
↙ 60

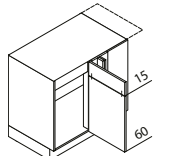

UESA Sink base unit space filler

↔ 110/115/125
↓ 75
↙ 60

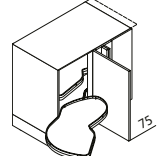

UELAD Corner base unit "LE MANS"

↔ 110/115/125
↓ 75
↙ 60

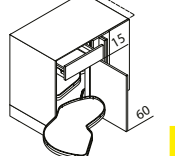

UELA Corner base unit

↔ 110/115/125
↓ 75
↙ 60

6

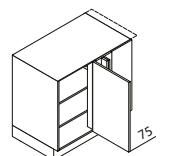

UEEAD Corner base unit

↔ 110/115/125
↓ 75
↙ 60/50

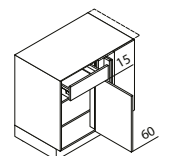

UEEA Corner base unit

↔ 110/115/125
↓ 75
↙ 60/50

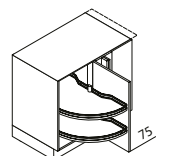

UEAD Corner base unit

↔ 110/115/125
↓ 75
↙ 60

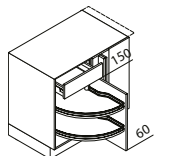

UEA Corner base unit

↔ 110/115/125
↓ 75
↙ 60

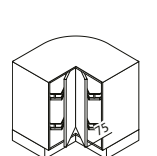

UEK Corner base unit

↔ 80/90
↓ 75
↙ 60

8

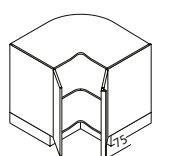

UEKE Corner base unit

↔ 80/90
↓ 75
↙ 60

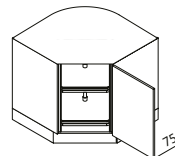

UETD Corner base unit

↔ 90
↓ 75
↙ 60

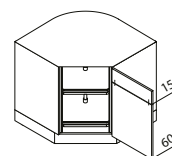

UET Corner base unit

↔ 90
↓ 75
↙ 60

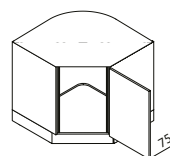

UETDE Corner base unit

↔ 90
↓ 75
↙ 60

Cooker and hob base units

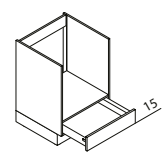

UHSK Cooker unit with drawer

↔ 60
↓ 75
↙ 60

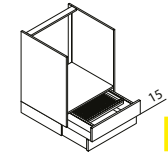

UHS Cooker unit with large-capacity pull-out

↔ 60
↓ 75
↙ 60

9

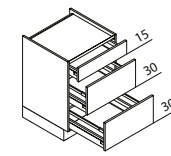

KUAK Hob base unit

↔ 60/80/90/100/120
↓ 75
↙ 60

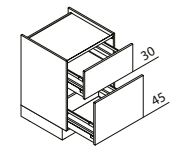

KUZ Hob base unit

↔ 60/80/90/100/120
↓ 75
↙ 60

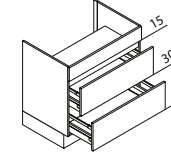

KAK-ML Hob base unit for downdraft extractor

↔ 60/80/90/100/120
↓ 75
↙ 60

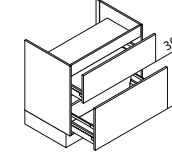

KUZ Hob base unit for downdraft extractor

↔ 60/80/90/100/120
↓ 75
↙ 60

Generate storage where space is otherwise left unused: the plinth drawer provides the answer.



6



7



8



9

Besides classic waste separation systems, Nolte Küchen also offers waste bins for corner units or even options for disposing of food preparation waste directly below the work surface.

BASE UNITS 90 cm

DISPLAY BASE UNITS 75 cm | 90 cm

90 cm units

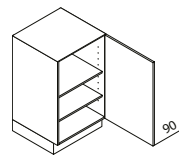

UDD Base unit
 ↳ 30/40/45/50/60
 ↓ 90
 ↙ 60/50/39

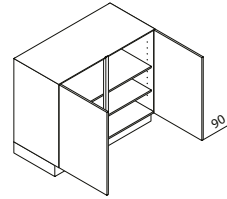

UDD Base unit
 ↳ 80/90/100/120
 ↓ 90
 ↙ 60/50/39

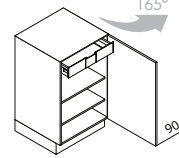

UDDI Base unit
 ↳ 40/45/50/60
 ↓ 90
 ↙ 60/50

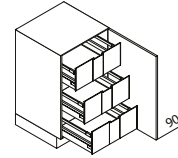

UIADD Base unit
 ↳ 40/45/50/60
 ↓ 90
 ↙ 60/50/39

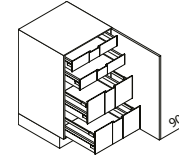

UIDD Base unit
 ↳ 40/45/50/60
 ↓ 90
 ↙ 60/50/39

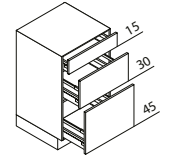

UAK Pull-out unit
 ↳ 30/40/45/50/60/80/90/100/120
 ↓ 90
 ↙ 60/50/39

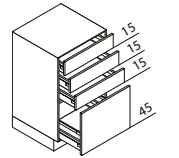

UAS Drawer base unit
 ↳ 30/40/45/50/60/80/90/100
 ↓ 90
 ↙ 60/50/39

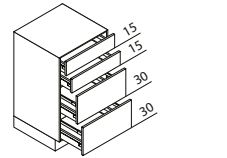

USA Drawer base unit
 ↳ 30/40/45/50/60/80/90/100/120
 ↓ 90
 ↙ 60/50/39

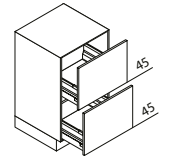

UZ Pull-out unit
 ↳ 30/40/45/50/60/80/90/100/120
 ↓ 90
 ↙ 60/50/39

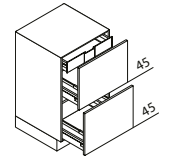

UZI Pull-out unit
 ↳ 30/40/45/50/60/80/90/100/120
 ↓ 90
 ↙ 60/50/39

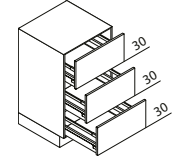

UAZ Pull-out unit
 ↳ 30/40/45/50/60/80/90/100/120
 ↓ 90
 ↙ 60/50/39

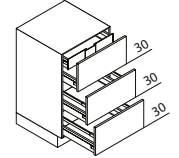

UAZI Pull-out unit
 ↳ 30/40/45/50/60/80/90/100/120
 ↓ 90
 ↙ 60/50/39

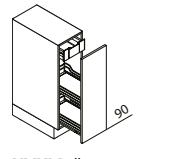

UVKI Pull-out unit with storage baskets
 ↳ 30
 ↓ 90
 ↙ 60

Corner unit

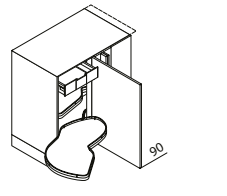

UELADI Space filler corner base unit, "LE MANS"
 ↳ 110/115/125
 ↓ 90
 ↙ 60

Sink base units

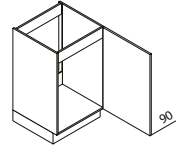

SOD Sink base unit
 ↳ 45/50/60
 ↓ 90
 ↙ 60

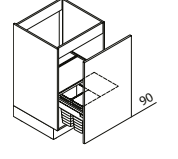

SABHD Sink base unit with waste separation system
 ↳ 45/50/60
 ↓ 90
 ↙ 60

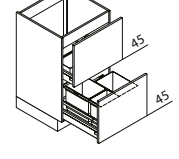

SUZ Sink base unit with waste separation system
 ↳ 60/80/90/100/120
 ↓ 90
 ↙ 60

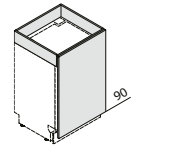

GSBBD Front panel for fully integratable dishwashers
 ↳ 60
 ↓ 90
 ↙ 60

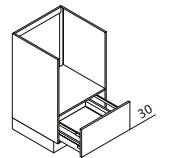

UHAZ Cooker unit
 ↳ 60
 ↓ 90
 ↙ 60

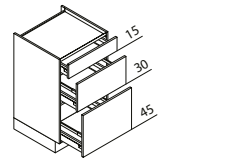

KUAK Hob base unit
 ↳ 60/80/90/100/120
 ↓ 90
 ↙ 60

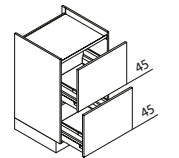

KUZ Hob base unit
 ↳ 60/80/90/100/120
 ↓ 90
 ↙ 60

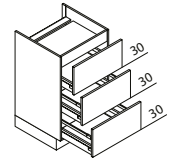

KAZ Hob base unit
 ↳ 60/80/90/100/120
 ↓ 90
 ↙ 60

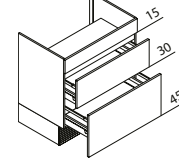

KAK-ML Hob base unit for downdraft extractor
 ↳ 60/80/90/100/120
 ↓ 75
 ↙ 60

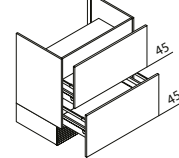

KUZ Hob base unit for downdraft extractor
 ↳ 60/80/90/100/120
 ↓ 75
 ↙ 60

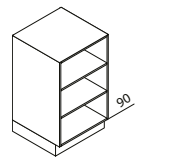

UR Open shelf base unit
 ↳ 15/20/25/30/35/40/45/50/55/60
 ↓ 90
 ↙ 60/39

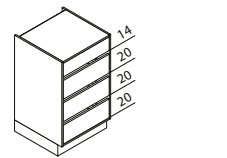

URI Base unit shelf with drawers
 ↳ 60/90
 ↓ 90
 ↙ 60/39

Display units

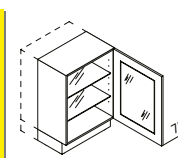

UDDV Base unit with glass door (depending on range)
 ↳ 40/45/50/60
 ↓ 75/90
 ↙ 60/39

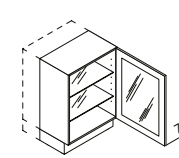

UDDDS Base unit with glass door DS
 ↳ 40/45/50/60
 ↓ 75/90
 ↙ 60/39

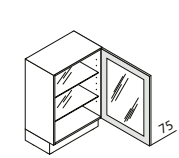

UDDDN Base unit with glass door DN
 ↳ 40/45/50/60
 ↓ 75/90
 ↙ 39

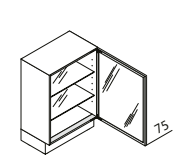

UDDDR Base unit with glass door DR
 ↳ 40/45/50/60
 ↓ 75/90
 ↙ 39

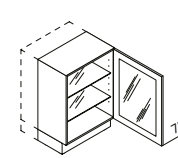

UDDDF Base unit with glass door DF
 ↳ 40/45/50/60
 ↓ 75/90
 ↙ 60/39

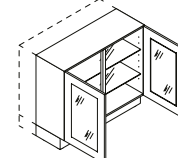

UDDV Base unit with glass door (depending on range)
 ↳ 80/90/100/120
 ↓ 75/90
 ↙ 60/39

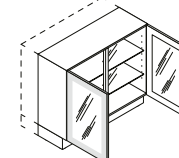

UDDDS Base unit with glass door DS
 ↳ 80/90/100/120
 ↓ 75/90
 ↙ 60/39

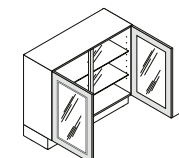

UDDDN Base unit with glass door DN
 ↳ 80/90/100/120
 ↓ 75/90
 ↙ 39

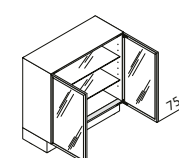

UDDDR Base unit with glass door DR
 ↳ 80/90/100/120
 ↓ 75/90
 ↙ 39

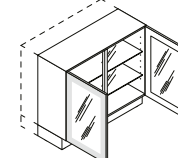

UDDDF Base unit with glass door DF
 ↳ 80/90/100/120
 ↓ 75/90
 ↙ 60/39



Note:
 glass display cabinets in a carcass height of 90 cm are only available in a carcass depth of 39 cm!

DISPLAY CABINET GLASS & FRAME DESIGNS

Glass types

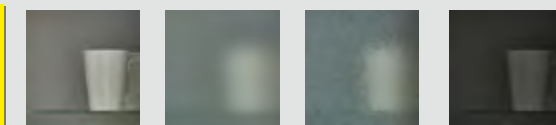

KAG Plain glass
SAG Satin-finish glass
FRE Glass frieze
SGG Glass tinted black

The glass types shown here can be selected for the product-related glass doors.

Frame design DF



WLG Glass, white lacquered
SWG Satin-finish glass / grey

Frame design DS



SAG Satin-finish glass
PGG Parsol glass, grey
SGG Glass tinted black

Frame design DN



PGB Parsol glass, bronze with aluminium frame
SGG Glass tinted black with aluminium frame

Frame design DR

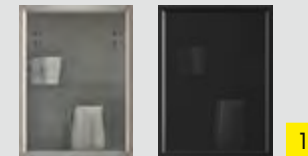

KAG Clear glass with narrow aluminium frame
SGG Glass tinted black, with narrow aluminium frame



MY INTERIOR ORGANISATION



The fastest way to **perfect organisation** in the kitchen.



The interior drawers and pull-outs behind the large front panels can be perfectly organised as well.

Individually tailored drawer organisation always provides perfect storage for kitchen utensils of any kind.

ORGANISATION IS A (KITCHEN) JOB HALF DONE

Making the other half a real pleasure. In a Nolte kitchen at least – because it provides perfect solutions to organising the interior of drawers and pull-outs: various systems are available, ranging from plastic and modular organisational units to genuine ash wood in black.



LAMINATE



REAL OAK



REAL ASH WOOD, BLACK

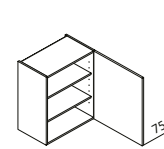
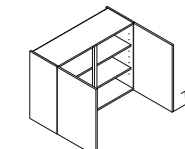
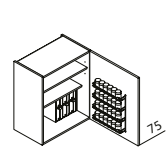
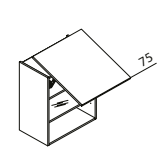
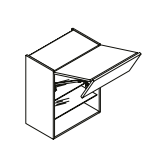
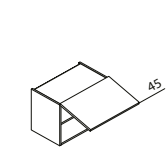

WALL UNITS 30 | 45 | 60 | 75 | 90 | 105 | 120 | 135 cm

 <p>H Wall unit ↔ 30/40/45/50/60 ↓ 45/60/75/90/105/120/135 ↙ 35/60* * = only available in heights up to 90 cm</p>	 <p>H Wall unit ↔ 80/90/100/120 ↓ 45/60/75/90 ↙ 35/60* * = only available in heights up to 90 cm</p>	 <p>HGL Spice cupboard ↔ 30/40/45/50/60 ↓ 60/75/90 ↙ 35</p>	 <p>HL Pivoting flap door unit ↔ 45/50/60/80/90/100/120* ↓ 60/75 ↙ 35/60 * = only available in 60 cm height</p>	 <p>HFK Folding top-hinged door unit ↔ 45/50/60/80/90/100/120* ↓ 60/75 ↙ 35/60 * = only available in 60 cm height</p>	 <p>HK Wall unit ↔ 45/50/60/80/90/100/120 ↓ 45 ↙ 35/60</p>
--	--	--	--	---	---

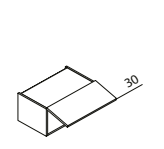
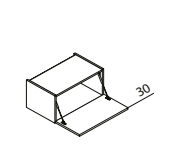
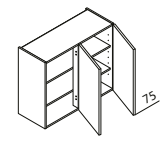
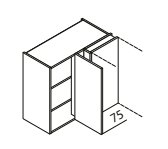
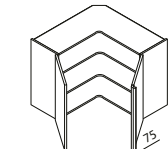
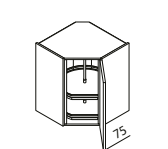
 <p>H Wall unit ↔ 30/40/45/50/60/80/90/100/120 ↓ 30 ↙ 35/60</p>	 <p>HBF Wall unit with bar flap ↔ 60/80/90/100/120 ↓ 30/45 ↙ 35/50</p>	 <p>HEK Wall unit ↔ 80/90 ↓ 60/75/90 ↙ 35</p>	 <p>HES Corner wall unit ↔ 80/90 ↓ 60/75/90 ↙ 35</p>	 <p>HE Corner wall unit ↔ 65/80/90 ↓ 60/75/90 ↙ 35</p>	 <p>HET Corner wall unit ↔ 60 ↓ 60/75/90 ↙ 35</p>
---	---	--	--	---	--

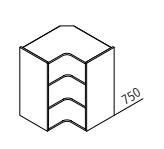
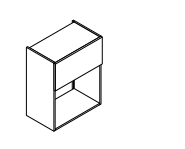
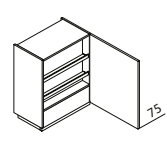
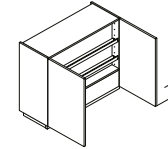
 <p>HER Corner wall shelf unit ↔ 60/65 ↓ 60/75/90 ↙ 35</p>	 <p>HM Wall unit for microwave ↔ 50/60 ↓ 60/75/90/105 ↙ 35</p>	 <p>HWU Wall unit for integrated extractor ↔ 60 ↓ 45/60/75/90/105 ↙ 35</p>	 <p>HWU Wall unit for integrated extractor ↔ 90 ↓ 45/60/75/90/105 ↙ 35</p>
--	---	---	--

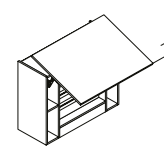
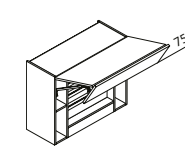
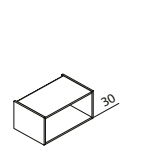
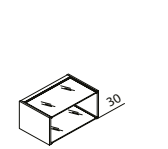
 <p>HWUL Pivoting flap door unit for integrated extractor ↔ 80/90/100/120* ↓ 60/75 ↙ 35 * = only available in 60 cm height</p>	 <p>HWUFG Folding flap door unit for integrated extractor ↔ 80/90/100/120* ↓ 60/75 ↙ 35 * = only available in 60 cm height</p>	 <p>HR Wall shelf unit ↔ 30/40/45/50/60/80/90/100/120 ↓ 30 ↙ 35</p>	 <p>HRV Wall shelf unit with glass shelves ↔ 60/90/120 ↓ 30/45 ↙ 35</p>
---	--	--	---

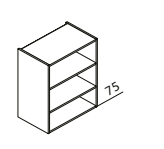
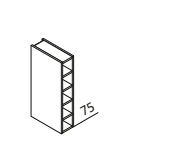
 <p>HR Wall shelf unit ↔ 15/20/25/30/35/40/45/50/55/60 ↓ 45/60/75/90/105 ↙ 35</p>	 <p>HF Wall unit bottle rack ↔ 15 ↓ 60/75/90 ↙ 35</p>
---	--

Matrix 150 even gives 35 cm deep wall units enough space to store large pasta plates.

WALL DISPLAY UNITS 30 | 45 | 60 | 75 | 90 | 105 | 120 | 135 cm

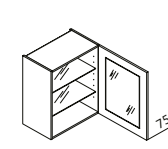
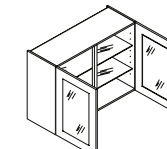
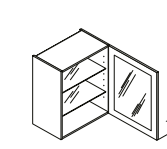
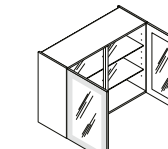
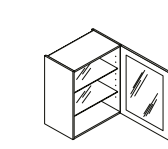
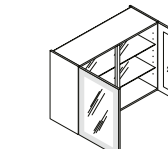

1

 <p>HV Wall unit with glass door (depending on range) ↔ 40/45/50/60 ↓ 60/75/90 ↙ 35</p>	 <p>HV Wall unit with glass door (depending on range) ↔ 80/90/100/120 ↓ 60/75/90 ↙ 35</p>	 <p>HVDS Wall unit with glass door DS ↔ 40/45/50/60 ↓ 60/75/90/105 ↙ 35</p>	 <p>HVDS Wall unit with glass door DS ↔ 80/90/100/120 ↓ 60/75/90 ↙ 35</p>	 <p>HVDF Wall unit with glass door DF ↔ 40/45/50/60 ↓ 60/75/90 ↙ 35</p>	 <p>HVDF Wall unit with glass door DF ↔ 80/90/100/120 ↓ 60/75/90 ↙ 35</p>
--	--	--	--	--	--

2

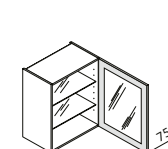
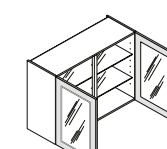
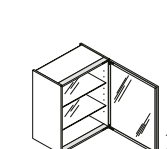
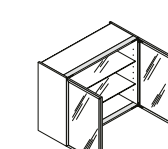
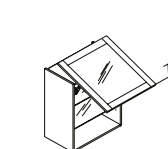
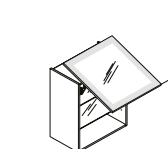
 <p>HVDN Wall unit with glass door DN ↔ 40/45/50/60 ↓ 60/75/90/105 ↙ 35</p>	 <p>HVDN Wall unit with glass door DN ↔ 80/90/100/120 ↓ 60/75/90 ↙ 35</p>	 <p>HVDR Wall unit with glass door DR ↔ 40/45/50/60 ↓ 60/75/90/105/120/135 ↙ 35</p>	 <p>HVDR Wall unit with glass door DR ↔ 80/90/100/120 ↓ 60/75/90 ↙ 35</p>	 <p>HLV Pivoting flap door unit with glass door (depending on range) ↔ 45/50/60/80/90/100/120* ↓ 60/75 ↙ 35 * = only available in 60 cm height</p>	 <p>HLDS Pivoting flap door unit with glass DS ↔ 45/50/60/80/90/100/120* ↓ 60/75 ↙ 35 * = only available in 60 cm height</p>
--	--	--	--	--	--

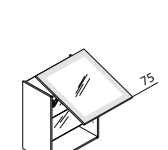
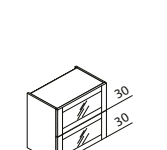
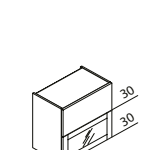
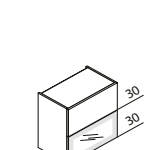
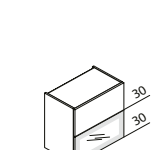
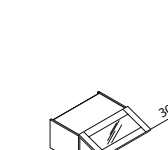
 <p>HLDF Pivoting flap door unit with glass DF ↔ 45/50/60/80/90/100/120* ↓ 60/75 ↙ 35 * = only available in 60 cm height</p>	 <p>HFKV Folding flap door unit with glass door (depending on range) ↔ 45/50/60/80/90/100/120 ↓ 60/75 ↙ 35</p>	 <p>HFKVPU Folding flap door unit with glass door (depending on range) ↔ 45/50/60/80/90/100/120 ↓ 60/75 ↙ 35</p>	 <p>HFKDSPU Folding flap door unit with glass DS ↔ 45/50/60/80/90/100/120 ↓ 60/75 ↙ 35</p>	 <p>HFKDPU Folding flap door unit with glass DF ↔ 45/50/60/80/90/100/120 ↓ 60/75 ↙ 35</p>	 <p>HV Wall unit with glass door (depending on range) ↔ 45/50/60/80/90/100/120 ↓ 30 ↙ 35</p>
--	---	---	---	--	---

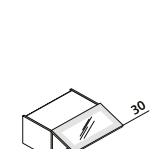
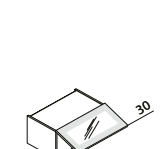
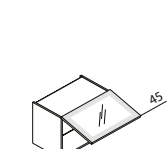
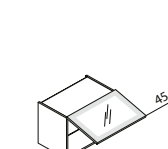
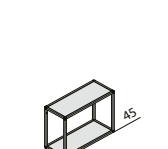
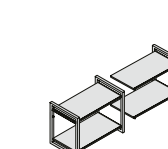
 <p>HVDS Wall unit with glass DS ↔ 45/50/60/80/90/100/120 ↓ 30 ↙ 35</p>	 <p>HVDF Wall unit with glass DF ↔ 45/50/60/80/90/100/120 ↓ 30 ↙ 35</p>	 <p>HKDS Wall unit with glass DS ↔ 60/80/90/100/120 ↓ 45 ↙ 35</p>	 <p>HKDF Wall unit with glass DF ↔ 60/80/90/100/120 ↓ 45 ↙ 35</p>	 <p>HRALU Open shelf unit, aluminium, black or stainless steel look ↔ 60/90/120 ↓ 30/45/60 ↙ 35</p>	 <p>HRM Shelf system, metal black - extendible ↔ 60 ↓ 45 ↙ 35</p>
--	--	--	--	--	--

2



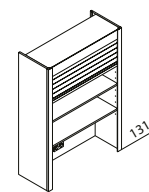

H AJ Top-mounted unit with tambour door in metal look
 ↳ 50/60/80/90
 ↓ 115/130/145
 ↶ 35/50/60

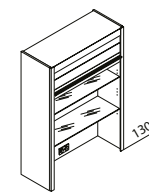

H AJGO Top-mounted unit with glass-look tambour door
 ↳ 60/90
 ↓ 115/130/145
 ↶ 35/50/60
 Available in black soft mat or high-gloss black

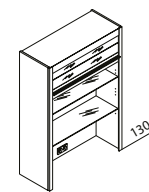

H AJJV Top-mounted unit with glass-look tambour door
 ↳ 50/60/80/90
 ↓ 115/130/145
 ↶ 35/50/60

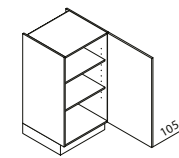

V Larder unit
 ↳ 30/40/45/50/60
 ↓ 105
 ↶ 60/50/35

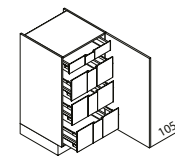

VI Larder unit
 ↳ 40/45/50/60
 ↓ 105
 ↶ 60/50/35

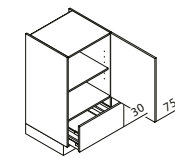

VA Larder unit
 ↳ 30/40/45/50/60
 ↓ 105
 ↶ 60/50

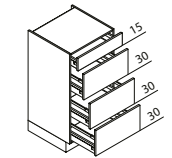

VAK Larder unit
 ↳ 30/40/45/50/60
 ↓ 105
 ↶ 60/50

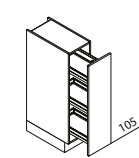

VVA Larder unit
 ↳ 30/40
 ↓ 105
 ↶ 60

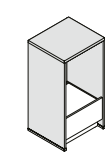

WA-GUB Panel surround for raised dishwasher
 ↳ 60
 ↓ 105
 ↶ 60

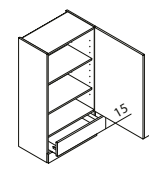

HASK Top-mounted unit
 ↳ 45/50/60
 ↓ 115/
 ↶ 35

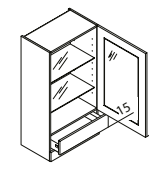

HASKV Top-mounted unit with glass door (depending on range)
 ↳ 45/50/60
 ↓ 115
 ↶ 35

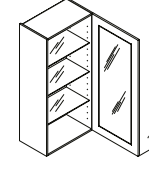

HAVDN Top-mounted unit with DN glass door
 ↳ 45/50/60
 ↓ 115/130/145
 ↶ 35

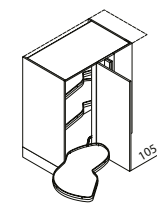

VELA Corner larder unit
 ↳ 110/115/125
 ↓ 105
 ↶ 60

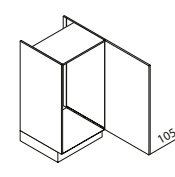

GK Appliance unit for refrigerator / recess 102.5cm
 ↳ 60
 ↓ 105
 ↶ 60

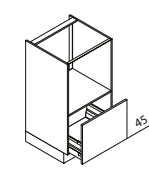

GBZ Appliance housing for oven or microwave
 ↳ 60
 ↓ 105
 ↶ 60

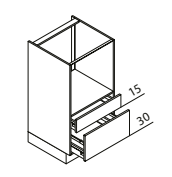

GBAS Appliance unit for oven or microwave
 ↳ 60
 ↓ 105
 ↶ 60

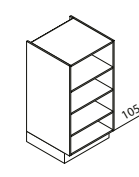

SR Open shelf units
 ↳ 20/25/30/40/45/50/60
 ↓ 105
 ↶ 60

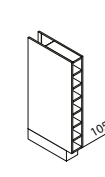

SF Bottle rack
 ↳ 15
 ↓ 105
 ↶ 60

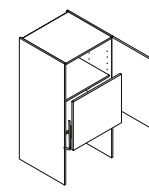

HAL Top-mounted unit with lift-up door
 ↳ 60
 ↓ 115/130/145
 ↶ 60

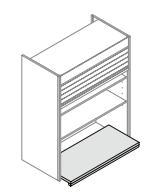

HAAB Pull-out shelf with TipOn for top-mounted units
 ↳ 50/60/80/90
 ↶ 50/60



Planning tip:
 the final height of the top-mounted cabinets shown here is automatically matched to suit the worktop thickness!

2



Simply turn your appliance housings into a sideboard: the tall-unit height of 105cm gives you even more ways of opening up the design of the kitchen.

LARDER UNITS AND APPLIANCE HOUSINGS 135 | 150cm

The drawings show 150 cm carcass height.

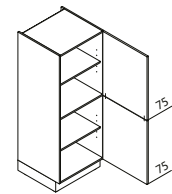

V Larder unit
 ↔ 30/40/45/50/60
 ↓ 135/150
 ↙ 60/50/35

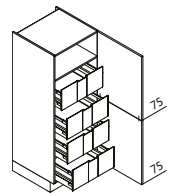

VI Larder unit
 ↔ 40/45/50/60
 ↓ 135/150
 ↙ 60/50/35

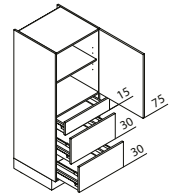

VAK Larder unit
 ↔ 30/40/45/50/60
 ↓ 135/150
 ↙ 60/50

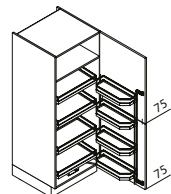

VVK Larder unit
 ↔ 60
 ↓ 135/150
 ↙ 60

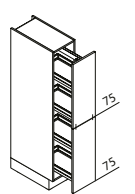

VVA Larder unit
 ↔ 30/40
 ↓ 135/150
 ↙ 60



1



2

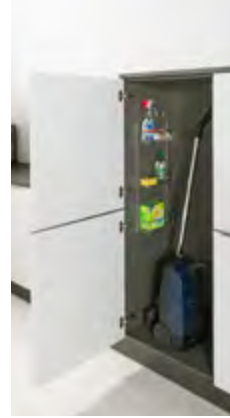

3



4

LARDER UNITS AND APPLIANCE HOUSINGS 195 | 210 | 210cm

The drawings show 210 cm carcass height.

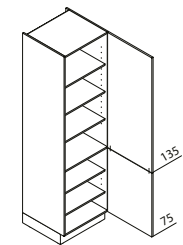

V Larder unit
 ↔ 30/40/45/50/60
 ↓ 195/210/225
 ↙ 60/50/35

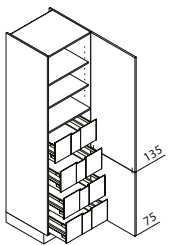

VI Larder unit
 ↔ 40/45/50/60
 ↓ 195/210/225
 ↙ 60/50/35

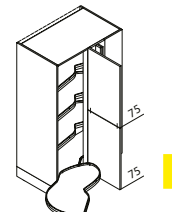

VELA Corner larder unit
 ↔ 110/115/125
 ↓ 135/150
 ↙ 60

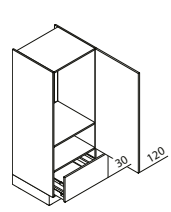

GKA Appliance unit for refrigerator / recess 88 cm
 ↔ 60
 ↓ 135/150
 ↙ 60

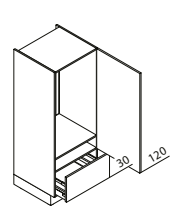

GKA Appliance unit for refrigerator / recess 102.5 cm
 ↔ 60
 ↓ 135/150
 ↙ 60

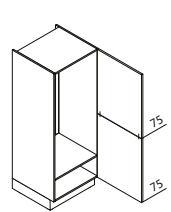

GK Appliance unit for refrigerator / recess 122.5 cm
 ↔ 60
 ↓ 135/150
 ↙ 60

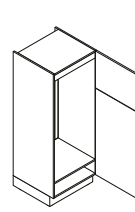

GKG Appliance housing for refrigerator / freezer combination / recess 122.5 cm
 ↔ 60
 ↓ 135/150
 ↙ 60

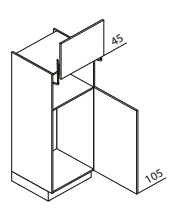

GKL Appliance housing with lift-up door for refrigerator / microwave / recess 88 cm
 ↔ 60
 ↓ 135/150
 ↙ 60

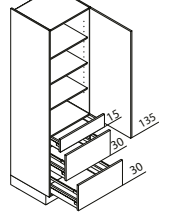

VAK Larder unit
 ↔ 30/40/45/50/60
 ↓ 195/210/225
 ↙ 60/50

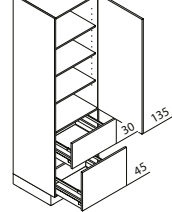

VZ Larder unit
 ↔ 30/40/45/50/60
 ↓ 195/210/225
 ↙ 60/50

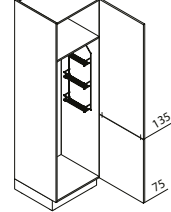

VB Broom cupboard
 ↔ 30/40/45/50/60
 ↓ 195/210/225
 ↙ 60/50

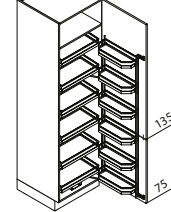

VVK Larder unit
 ↔ 60
 ↓ 195/210/225
 ↙ 60

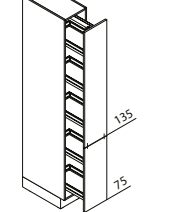

VVA Larder unit
 ↔ 30/40
 ↓ 195/210/225
 ↙ 60

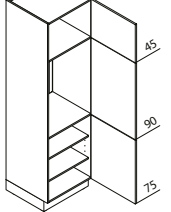

GK Appliance unit for refrigerator / recess 88 cm
 ↔ 60
 ↓ 195/210/225
 ↙ 60

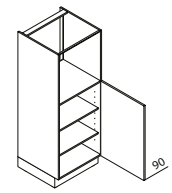

GB Appliance housing for oven or microwave
 ↔ 60
 ↓ 135/150
 ↙ 60

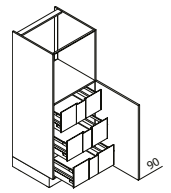

GBI Appliance housing for oven or microwave
 ↔ 60
 ↓ 135/150
 ↙ 60

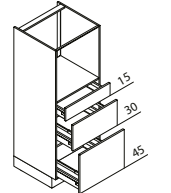

GBZ Appliance housing for oven or microwave
 ↔ 60
 ↓ 135/150
 ↙ 60

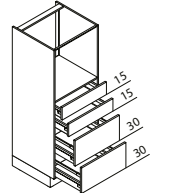

GBAP Appliance housing for oven or microwave
 ↔ 60
 ↓ 135/150
 ↙ 60

PLANNING INFORMATION

This example shows you how units vary in relation to carcass height:

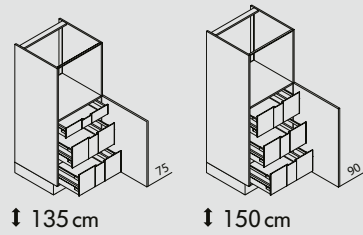

↓ 135 cm ↓ 150 cm

Appliance housings always adapt to the appliances fitted in them. Depending on make and appliance height, the units shown here can be varied in terms of front layout and number of drawers or pull-outs.

To give you an overall picture of the extensive range of storage units and appliance housings you can choose from, we have summarised the available carcass heights here in one illustration which shows only a selection of appliance housings.

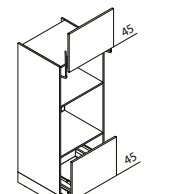

GBLA Appliance housing with lift-up door for oven and microwave
 ↔ 60
 ↓ 135/150
 ↙ 60

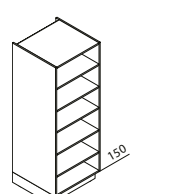

SR Open shelf units
 ↔ 20/25/30/35/40/45/50/55/60
 ↓ 135/150
 ↙ 60

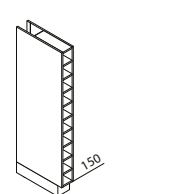

SF Bottle rack
 ↔ 15
 ↓ 135/150
 ↙ 60

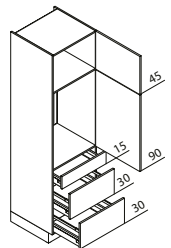

GKAK Appliance unit for refrigerator / recess 88 cm
 ↔ 60
 ↓ 195/210/225
 ↙ 60

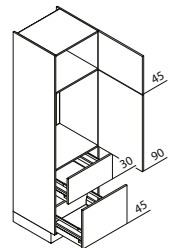

GKZ Appliance unit for refrigerator / recess 88 cm
 ↔ 60
 ↓ 195/210/225
 ↙ 60

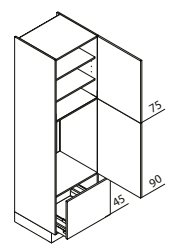

GKA Appliance unit for refrigerator / recess 88 cm
 ↔ 60
 ↓ 195/210/225
 ↙ 60

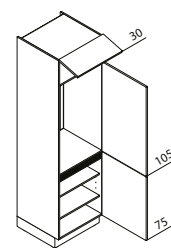

GK Appliance unit for refrigerator / recess 102.5 cm
 ↔ 60
 ↓ 195/210/225
 ↙ 60

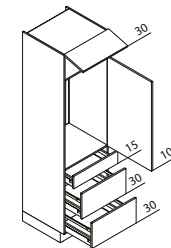

GKAK Appliance unit for refrigerator / recess 102.5 cm
 ↔ 60
 ↓ 195/210/225
 ↙ 60

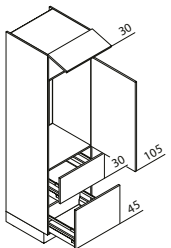

GKZ Appliance unit for refrigerator / recess 102.5 cm
 ↔ 60
 ↓ 195/210/225
 ↙ 60

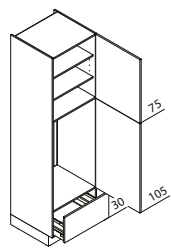

GKA Appliance unit for refrigerator / recess 102.5 cm
 ↔ 60
 ↓ 195/210/225
 ↙ 60

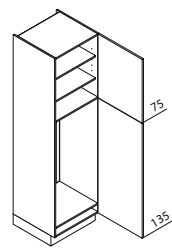

GK Appliance unit for refrigerator / recess 102.5 cm
 ↔ 60
 ↓ 195/210/225
 ↙ 60

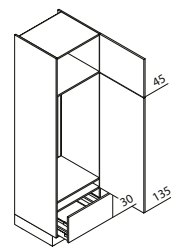

GKA Appliance unit for refrigerator / recess 122.5 cm
 ↔ 60
 ↓ 195/210/225
 ↙ 60

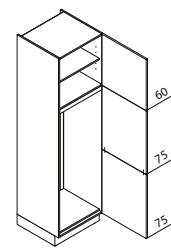

GK Appliance unit for refrigerator / recess 144 cm
 ↔ 60
 ↓ 195/210/225
 ↙ 60

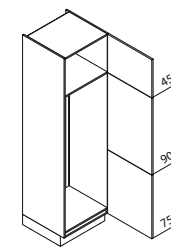

GKG Appliance unit for refrigerator / freezer combination / recess 158 cm
 ↔ 60
 ↓ 195/210/225
 ↙ 60

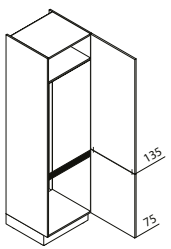

GK Appliance unit for refrigerator / recess 178 cm
 ↔ 60
 ↓ 195/210/225
 ↙ 60

LARDER UNITS AND APPLIANCE HOUSINGS 195 | 210 | 225 cm

The drawings show 210 cm carcass height.

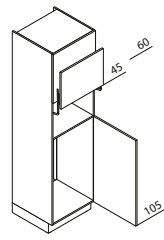

GKL Appliance housing with lift-up door for refrigerator / microwave / recess 102.5mm
 ↔ 60
 ↓ 195/210/225
 ↶ 60

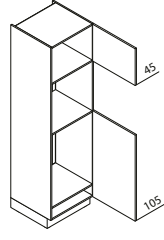

GKB Appliance housing for refrigerator and oven / recess 88 mm
 ↔ 60
 ↓ 195/210/225
 ↶ 60

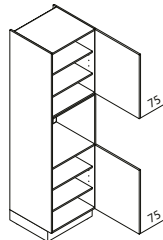

GB Appliance housing for oven / microwave
 ↔ 60
 ↓ 195/210/225
 ↶ 60

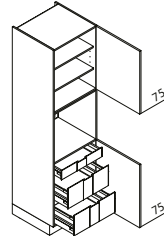

GBI Appliance housing for oven / microwave
 ↔ 60
 ↓ 195/210/225
 ↶ 60

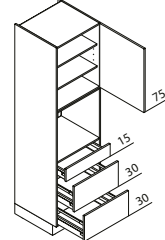

GBAK Appliance housing for oven / microwave
 ↔ 60
 ↓ 195/210/225
 ↶ 60

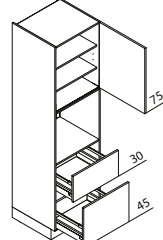

GBZ Appliance housing for oven / microwave
 ↔ 60
 ↓ 195/210/225
 ↶ 60

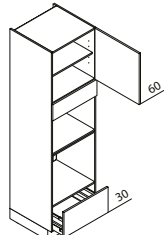

GBBA Appliance housing for oven / microwave
 ↔ 60
 ↓ 195/210/225
 ↶ 60

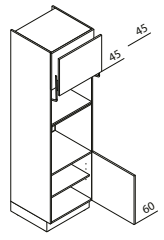

GBL Appliance housing with lift-up door for oven / microwave
 ↔ 60
 ↓ 195/210/225
 ↶ 60

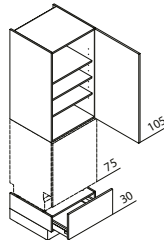

GSSA Appliance housing surround for dishwashers
 ↔ 60
 ↓ 195/210/225
 ↶ 60

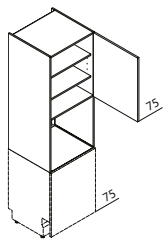

GGSB Appliance housing surround for dishwasher / oven
 ↔ 60
 ↓ 195/210/225
 ↶ 60

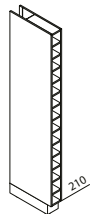

SF Bottle rack
 ↔ 15
 ↓ 195/210/225
 ↶ 60

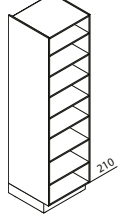

SR Open shelf units
 ↔ 20/25/30/35/40/45/50/55/60
 ↓ 195/210/225
 ↶ 60

PLANNING INFORMATION

To give you an overall picture of the extensive range you can choose from, we have summarised the available carcass heights here in one illustration which shows only a selection of appliance housings.

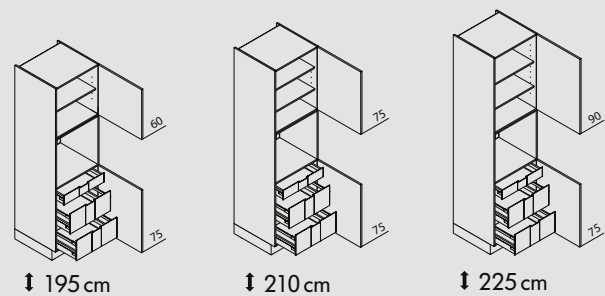

The example on the left shows you how units vary in relation to carcass height:

Appliance housings always adapt to the appliances fitted in them. Depending on make and appliance height, the units shown here can be varied in terms of front layout and number of drawers or pull-outs.

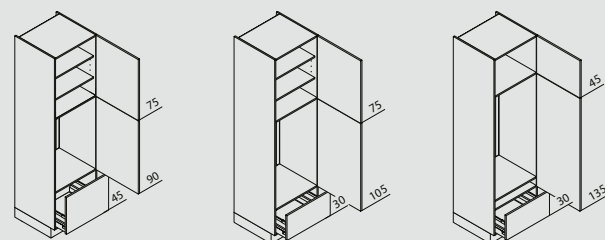

By way of example, an appliance housing for a refrigerator in 21 cm height with recess heights of 88, 102.5 and 122.5 cm (from left).

MY FRONTS

THE CHOICE IS YOURS

Do you like a homely, elegant look or prefer it classic? It doesn't matter – because at Nolte Küchen, you have all the options: here, individual taste and personal style are not a question of budget. From melamine resin to genuine lacquer, from plain colours to stone and wood decors, the sky's the limit.



ALL OPTIONS AT A GLANCE



LACQUERED LAMINATE

An extremely calm looking surface and optimum durability are characteristic of lacquered laminate. The fronts are made from an engineered wood panel with a lining lacquered in the course of the production process. High gloss or soft mat, just as you choose.



LAMINATE

A high-quality, soft mat and extremely hard-wearing laminate surface with anti-fingerprint properties.



GENUINE LACQUER

High-gloss genuine lacquer fronts are lacquered in several coats and then polished to produce a sealed and particularly smooth surface. Besides high-gloss fronts, fronts are also available with a soft mat genuine lacquer finish. The latter captivates with its interesting feel.



GENUINE GLASS

Genuine glass fronts – luxurious and homely. Coated with adhesive throughout, a back-lacquered pane of toughened safety glass is bonded to the high-quality substrate material. The extremely hard-wearing glass front gives the kitchen a modern transparency and feeling of space.



REAL WOOD

As an authentic and genuine natural product, wood conveys warmth and a sense of security. The natural variations in colour and texture visible in the grain are an inherent part of wood. Used in the kitchen, the natural material lends itself to quality craftsmanship while conveying its charm and character.



REAL METAL

The real metal fronts give your kitchen an authenticity that oozes with character: several layers of a mixture of metal particles, resins and colour are applied to a base panel made of engineered wood and sealed with clear lacquer. The result additionally impresses with a magnetic effect.



REAL CEMENT

The unusual feel of this surface is produced by creating irregular depressions in a panel made of engineered wood. It is then hand-coated with cement, silica and coloured lacquer and afterwards additionally sealed with clear varnish. Robust beauty for combinations so very rich in contrast.

MANHATTAN UNI | Price group 1

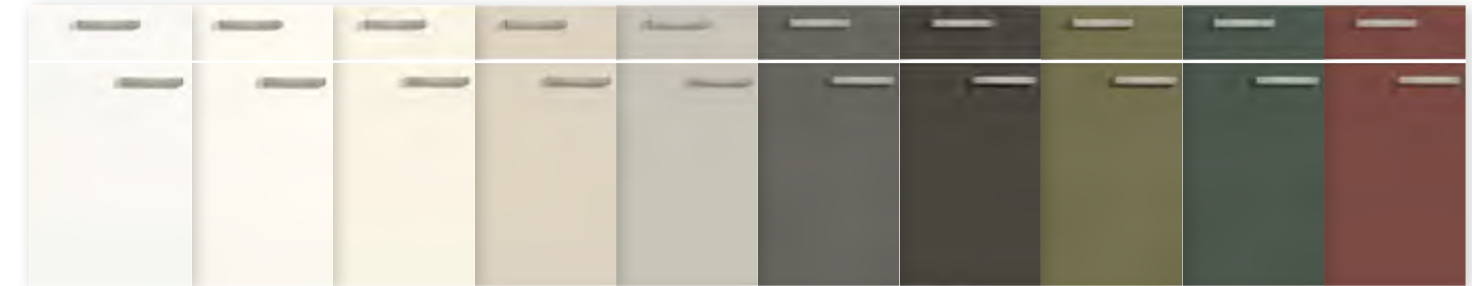

48a Arctic white | 490 White | 491 Magnolia | 498 Sahara | 48p Platinum grey | 48q Quartz grey | 48g Graphite | 48o Olive | 48b Black green | 48h Henna red

MANHATTAN | Price group 1



49B Kiruna brich | 48S Holm oak | 495 Chalet oak | 489 Volcanic oak | 486 Oak graphite silver | 48N Oak nero

LUCCA | Price group 1



245 Cement sapphire grey | 243 Cement agate grey | 244 Cement anthracite

ARTWOOD | Price group 2

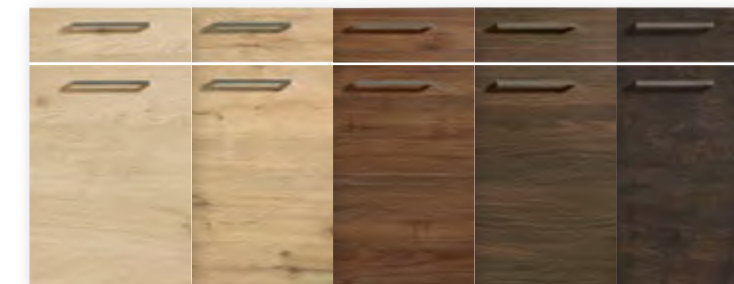

22N Natural bough oak | 22W Rustic wild oak | 22R Walnut royal | 22K Walnut cuba | 22G Flame scarfed oak

STONE | Price group 2



267 Concrete white | 263 Concrete | 262 Basalt

METAL | Price group 2



675 Steel grey | 676 Copper oxide

This is where you can quickly find your way about all available options: The next few pages show you our wide range of fronts that are manufactured in line with the innovative Matrix 150 grid system and can feature any handle you choose – all clearly structured by price group.



FEEL | Price group 2

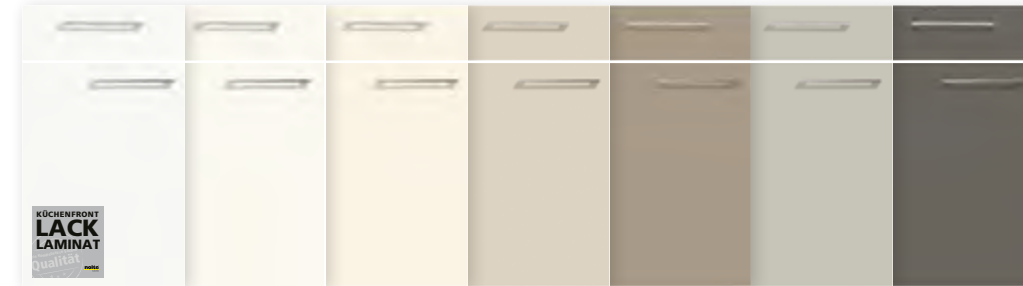

- 96A Arctic white soft mat
- 961 White soft mat
- 962 Magnolia soft mat
- 968 Sahara soft mat
- 967 Lava soft mat
- 96P Platinum grey soft mat
- 96G Quartz grey soft mat

LUX | Price group 2

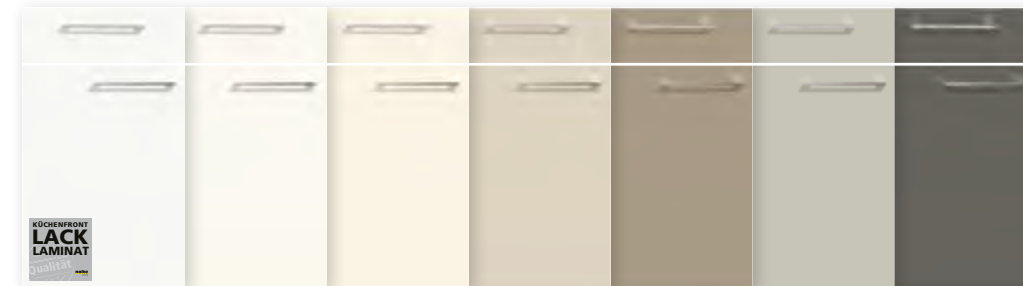

- 36A High-gloss arctic white
- 361 High-gloss white
- 362 High-gloss magnolia
- 368 High-gloss sahara
- 367 High-gloss lava
- 36P High-gloss platinum grey
- 36G High-gloss quartz grey

PLUS | Price group 3



- 601 White soft mat
- 60P Platinum grey soft mat
- 60L Lava soft mat
- 60Q Quartz grey soft mat
- 60G Graphite soft mat
- 60S Black soft mat

FOCUS | Price Group 3

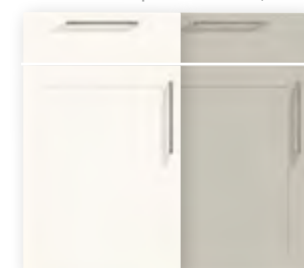

- 831 White soft mat
- 83P Platinum grey soft mat

PORTO | Price group 3

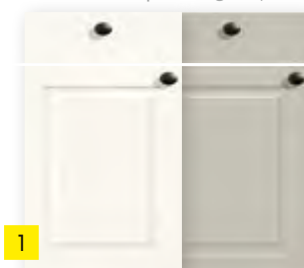

- 811 White soft mat
- 81P Platinum grey soft mat



FINE LACK | Price group 4



- 52A High-gloss arctic white
- 521 High-gloss white
- 52P High-gloss platinum grey
- 52G High-gloss graphite

VENTA | Price group 3

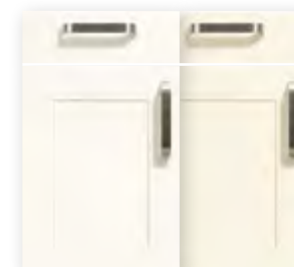

- 911 White
- 912 Magnolia

FLAIR | Price group 4

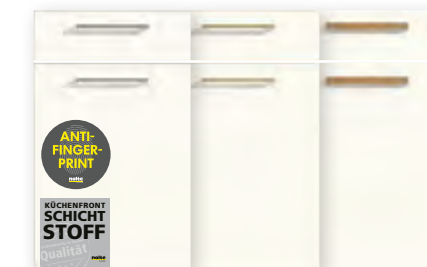

- 935 White / edging in stainless steel look
- 936 White / edging in brass look
- 937 White / edging in volcanic oak

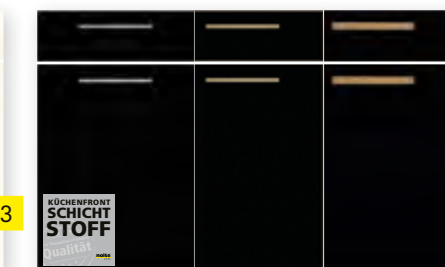

- 955 Black / edging in stainless steel look
- 956 Black / edging in brass look
- 957 Black / edging in volcanic oak

SIGMA LACK | Price group 5



- D01 White soft mat
- D03 Quartz grey soft mat

ALPHA LACK | Price group 5

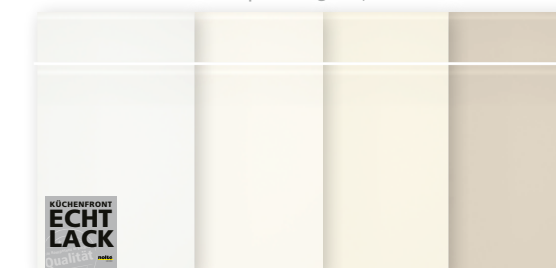

- 55A High-gloss arctic white
- 551 High-gloss white
- 552 High-gloss magnolia
- 558 High-gloss sahara

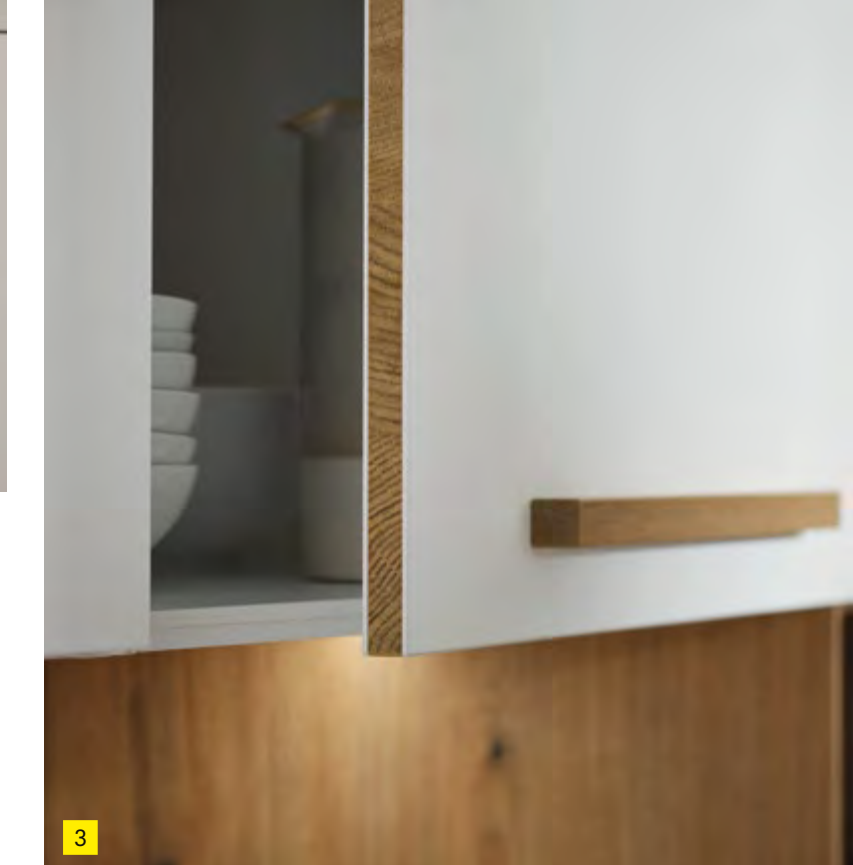

MY FRONTS

NOVA LACK | Price group 6

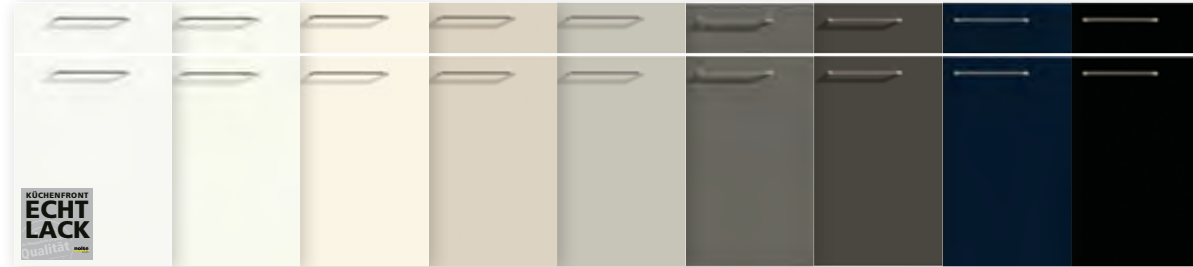

73A High-gloss arctic white
 731 High-gloss white
 732 High-gloss magnolia
 738 High-gloss sahara
 73P High-gloss platinum grey
 73Q High-gloss quartz grey
 73H High-gloss graphite
 73T High-gloss deep blue
 73N High-gloss night black

PORTLAND | Price group 6



405 Cement sapphire grey
 403 Cement agate grey
 404 Cement anthracite

FERRO | Price group 6



701 Blue steel
 702 Corten steel

TAVOLA | Price group 6



571 Oak pinot
 572 Oak barolo

FINE LACK in platinum grey is an absolute eye-catcher on gloss fronts. Combining this with TAVOLA in oak barolo makes a homely statement.

GLAS TEC PLUS | Price group 7



16W High-gloss white

GLAS TEC SATIN | Price group 7

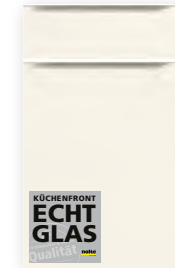

17W White

ELEGANCE | Price group 7



340 High-gloss white

LEGNO | Price group 8

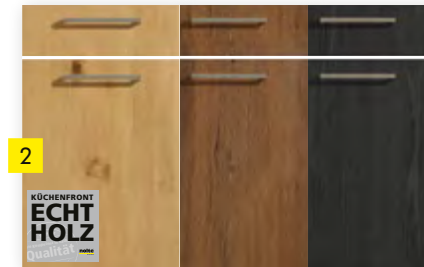

59C Oak champagne
 59T Oak truffle
 59T Oak sepia



PERFECTLY BALANCED IN ANY COMBINATION

Colour is inspiration, stimulation, creativity. Colour is life. And provides virtually endless ways of individualising a kitchen. Warm colours are stimulating, while cool colours have a calming effect. Tone in tone creates harmony, leaving clear contrasts to create exciting highlights. In short: nothing influences the atmosphere of a room more than colour. With this in mind, get to know our colour concept – and get to know precisely your kitchen.

SOFT LACK
PRICE GROUP 4

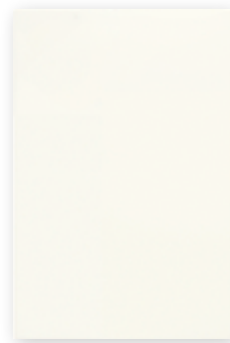

TORINO LACK
Price group 6

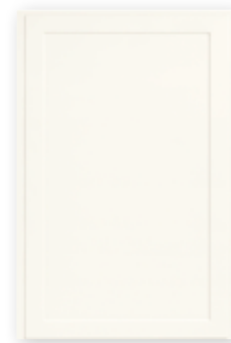

FRAME LACK
Price group 6



WINDSOR LACK
Price group 6



LUGANO LACK
Price group 7



COLOUR ... FOR LIVING IN THE KITCHEN

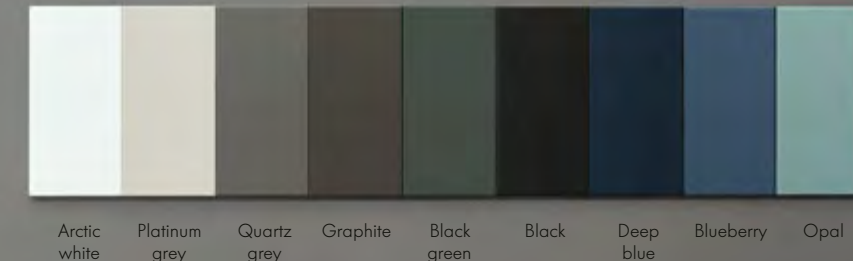

Genuine lacquer for a modern and classy ambience in your kitchen.

A SPLASHBACK MAKES AN ENTRANCE

Our bespoke and elegant alternative to classic splashback panelling: sometimes innovative and fresh, sometimes calm and perfectly balanced – choose from a wide selection of mood-conjuring motifs that will create a special feel-good ambience in any kitchen. All of the motifs shown are optionally available in the form of printed wood-based panel or glass splashback. On request, the latter are also available with illumination.



M12 Rusty steel



M07 Natural stone look, lime



M09 Natural stone look, rustica



M26 Marble beige



M24 Brick wall



M23 Mosaic tiles grey



M16 Ornamental grey



M29 Marble tile white



M05 Brick



M27 Patchwork style



PLANNING INFORMATION

The printed backsplashes are available in the following sizes:

Wood-based panel: 60–280 cm
Glass splashback: 60–180 cm

Needless to say, any worktop decor can also be used on the splashback. Available decors can be found on pages 71–73.



M42 Beach path



M40 Beach dunes

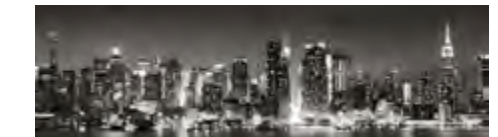

M33 Skyline by night



M38 Reed stalks

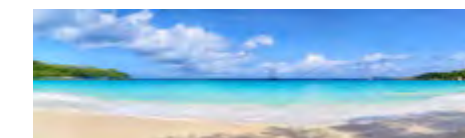

M30 Seychelles



M43 Switzerland



M36 Herbs and blooms



M46 Mountain scenery



M41 Forest panorama



M34 Mortar with herbs



M32 Tuscany



M35 Taste of wine

STANDARD AND RAIL HANDLES

The handle as design element: handles put the finishing touches on every successfully planned kitchen. Give your kitchen a personal stamp with the right handle – precisely the one that goes with you. And with your kitchen.



1

































2



3



HANDLES

-  G 318
Stainless steel look
-  G 322
Stainless steel look
-  G 8AB
Stainless steel look
-  G 8CB
Stainless steel look
-  G 8NB
Stainless steel look
-  G 340
Stainless steel look, dark brushed
-  G 8OB
Stainless steel look
-  G 349
Stainless steel look
-  G 352
Stainless steel look
-  G 444
Stainless steel look
-  G 7QB
Old metal
-  G 7ZB
Old copper
-  G 353
Gloss black
-  G 9LB
Titanium look
-  G 9KB
Black
-  G 218
Brass look
-  G 217
Black coated
-  G 9MB
Volcanic oak
-  G 317
Stainless steel look
-  G 336
Stainless steel look
-  G 209
Stainless steel look
-  G 354
Stainless steel look
-  G 216
antique anthracite
-  G 207
black
-  G 350
Stainless steel look
-  G 225
Stainless steel look
-  G 9JB
Stainless steel look
-  G 335
antique brown
-  G 9IA
black
-  G 338
Stainless steel look

HANDLES

-  G 304
Stainless steel look, dark brushed
-  G 425
Stainless steel look
-  G 7AA
Stainless steel look
-  G 313
Stainless steel look, dark brushed
-  G 329
Stainless steel look
-  G 7EA
Stainless steel look
-  G 351
Stainless steel look
-  G 7TA
Stainless steel look
-  G 7SA
Stainless steel look
-  G 204
Stainless steel look
-  G 8VA
Stainless steel look
-  G 9AA
Black
-  G 208
Manganese bronze

KNOBS

-  K 138
Stainless steel look
-  K 140
Antique black
-  K 141
Stainless steel look
-  K 143
Black

RAIL HANDLES

-  Handle combination R12 – Stainless steel look
-  Handle combination R25 – Stainless steel look
-  Handle combination R45 – Stainless steel look
-  Handle combination R70 – Stainless steel look

HANDLE COMBINATIONS AND HANDLE TRIMS

HANDLE COMBINATIONS



Handle combination 826 – Stainless steel look



Handle combination 821 – Stainless steel look



Handle combination 835 – Manganese bronze



Handle combination 839 – Stainless steel look



Handle combination 849 – Stainless steel look



Handle combination 850 – Black



Handle combination 827 – Black



Handle combination 822 – Brown lacquered

HANDLE COMBINATIONS



Handle combination 848 – Stainless steel look



Handle combination 836 – Stainless steel look



Handle combination 838 – Stainless steel look



Handle combination 851 – Black

4

5

Handle combination 837 – Black



4

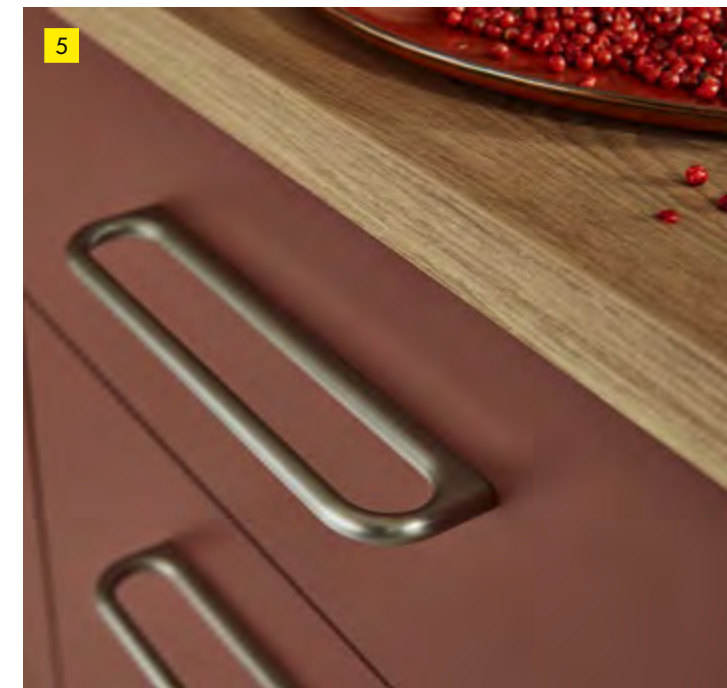

5



Note:
Handle trims are only available for selected front ranges. All handle trims can usually be fitted on large-surface doors. Your kitchen retailer will be pleased to advise you in detail.

6

HANDLE COMBINATIONS



Handle combination 829 – Stainless steel look



Handle combination 814 – Stainless steel look

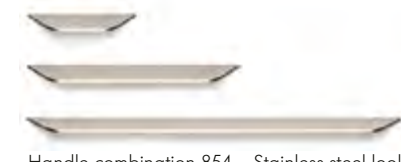

Handle combination 854 – Stainless steel look



Handle combination 855 – Volcanic oak



Handle combination 845 – Stainless steel look



Handle combination 852 – Black



Handle combination 853 – Titanium look

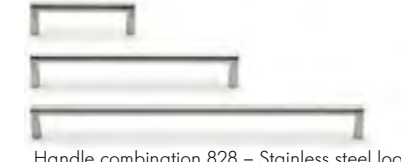

Handle combination 828 – Stainless steel look



Handle combination 811 – Antique metal



Handle combination 813 – Antique copper

HANDLE TRIMS



Handle trim 502 – metal look



Handle trim 530 – Polished chrome



Handle trim 560 – Metal look



Handle trim 561 – Black anodised



Handle trim 620 – Stainless steel look



Handle trim 621 – Stainless steel black



Handle trim 675 – Stainless steel look



Handle trim 676 – Stainless steel look

6

MY CARCASE DECORS

What impresses you at first sight will continue to excite you in everyday use: harmony and perfection carried through on the inside.



PERFECT BOTH INSIDE AND OUT

Whichever of our kitchens you choose: it's only perfect when it also meets the highest quality standards on the inside too. This is why the carcasses of every kitchen we make come with the same finish on the inside as they do on the outside to ensure an overall look of consistency – not only for wood hues but for all plain colours too.

SEALED IS WELL SEALED

With Nolte Küchen, you can take this quite literally: doors with edge seals close so perfectly that hardly any dust gets inside the cabinet.

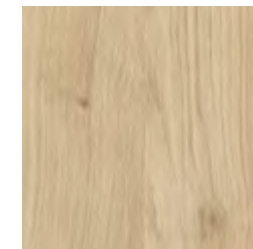

AEN Natural bough oak

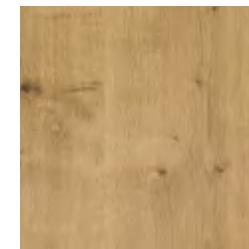

CED Chalet oak



ED9 Volcanic oak

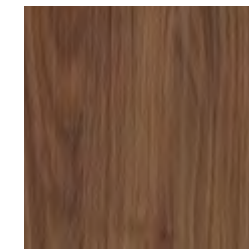

NBR Walnut royal



ARW Arctic white



PGD Platinum grey



QGD Quartz grey



GTD Graphite

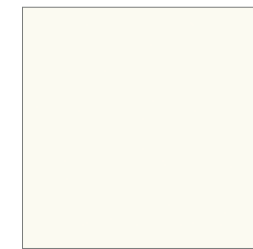

PWD Premium white

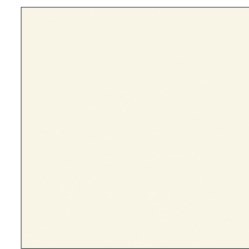

AWD Magnolia



SHD Sahara



BET Concrete



PWG Premium white gloss

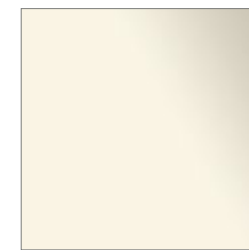

AWG Gloss magnolia



SHG Gloss sahara

On request, we can supply matching visible sides for most front decors for which no matching carcass is available. In this case, all carcass sides visible from the outside are finished in matching design.



Tip:

End panels give your kitchen a unique frame. Your kitchen adviser will be pleased to help you in matters of design and planning.

MY WORKTOPS



WOOD DECORS

NATURAL CHARM – WORKTOPS IN WOOD EFFECT

Anyone preferring a warm and homely environment in the kitchen sooner or later realises there is no way past a worktop in wood effect. There are numerous options in thicknesses of 25 and 40 mm. Choose from a wide range of decors to suit your taste, and all of course in a high-quality finish to meet your exacting expectations on design.

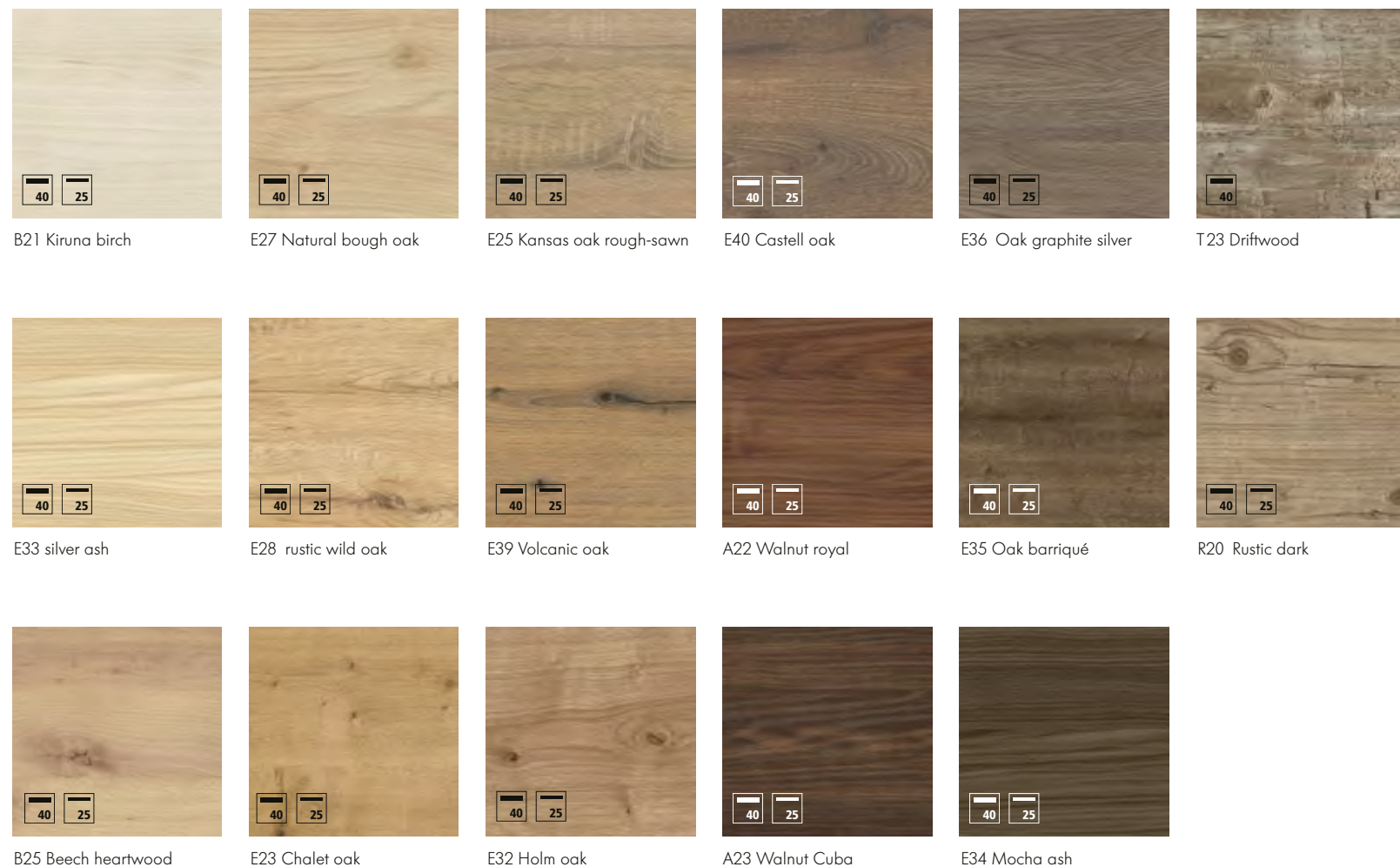

COOL ELEGANCE – WORKTOPS IN PLAIN COLOUR AND IN STONE EFFECT

Once the quality is right, it's a matter of design. For our worktops, this means: the choice is entirely yours. Clear plain colours lend the kitchen elegance, with a realistic stone look giving the entire room structure.



PLAIN AND STONE DECORS

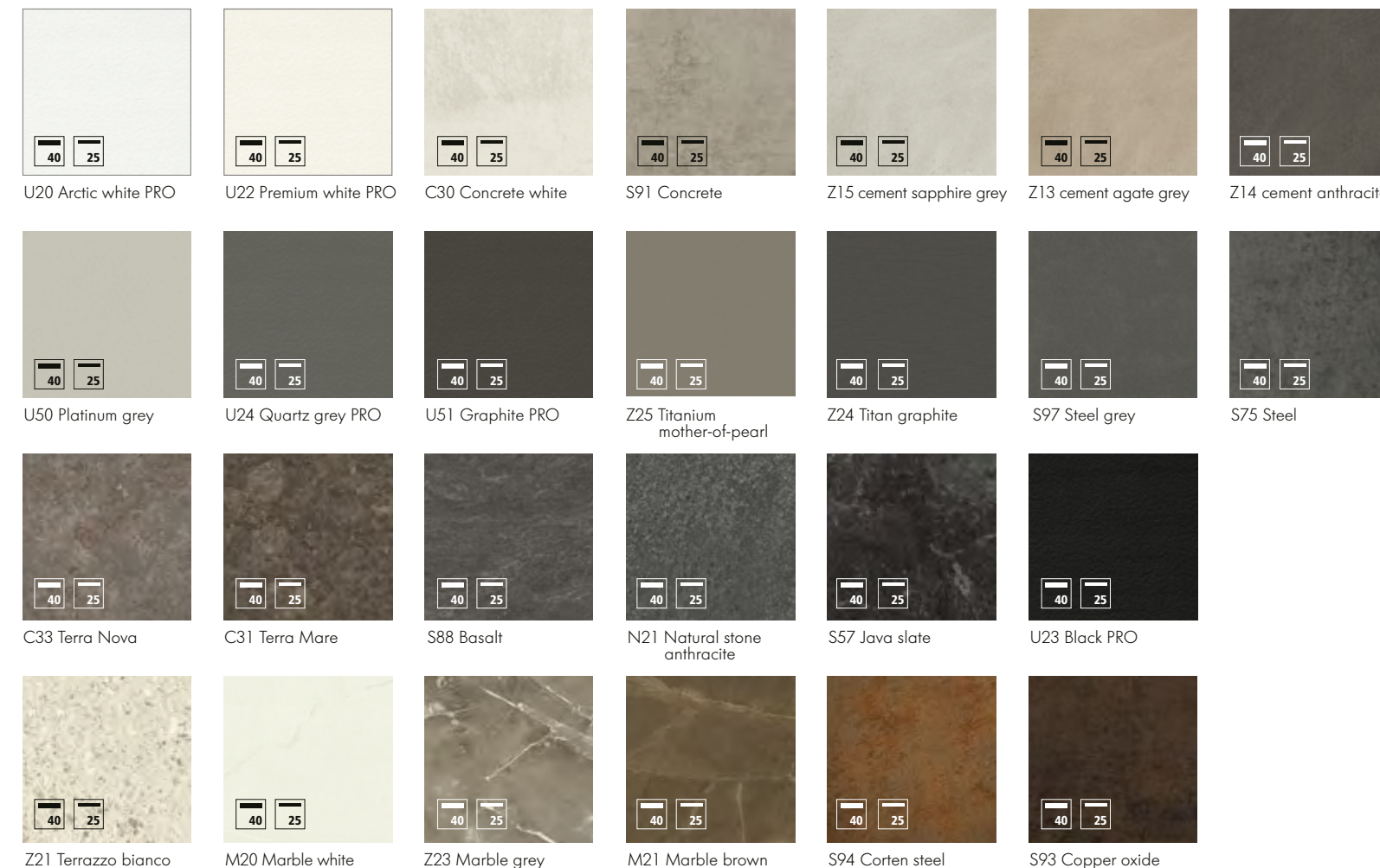

MY WORKTOPS



SLIM-LINE, DELICATE AND TOUGH

These worktops come with the right attributes for the kitchen: elegance, a light and airy feel and, with some of them, extreme durability, guaranteed for example by MDF substrate panels with laminate surfaces which are particularly tough and hard-wearing.

FLUSH-FITTING SINKS, HOBS AND POWER SOCKETS

Flush-fit sinks and hobs combine modern looks with easy maintenance – long-lasting and easy to clean. At last an end to irritating edges – nothing gets caught here, and your worktop is always clean and hygienic.



FIBREBOARD

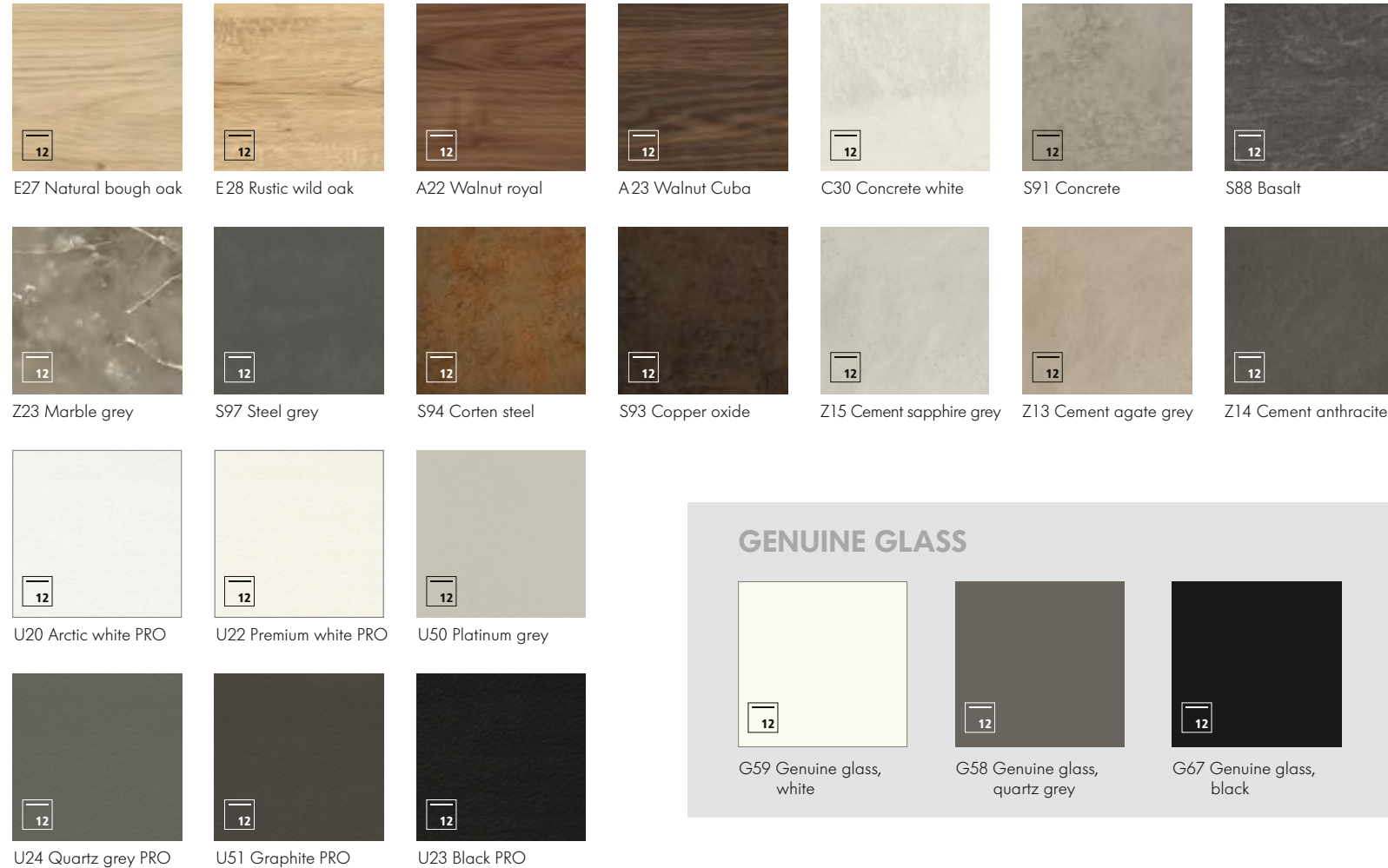

 = Worktops 12 mm thick



Whether sinks in stainless steel or granite, whether 40 or 25 mm worktop thickness: every decor is at your disposal! You can even choose any PRO decor for 12 mm worktops. Plus we have perfected the installation – so you can be sure that even after many years' use, there will be no impairment.



EVERYTHING STORED – NEXT TO THE KITCHEN

So, what sort of utility room would you like to have? This, of course, depends entirely on the space you have and on your personal needs. Some prefer to use it as a storage room for household items, others turn it into a lovely dressing room with numerous drawers providing plenty of space. Just as you please. Or create the perfect room divider: on the one hand a practical utility room with everything that goes with it, and, on the other hand, an attractive hallway area with coat rack and wall unit as a chest of drawers – where keys can be kept, for example.

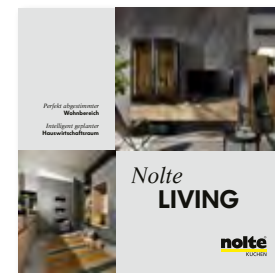

The fastest way to an efficiently planned and logically furnished utility room. Download details now.

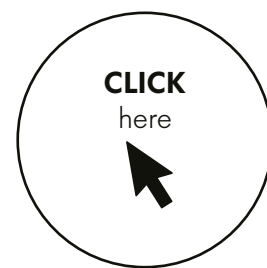

Perfectly planned for everyday things:

- Washing machine & tumble dryer
- Laundry
- Bottles and crates
- Household appliances
- Clothing
- Waste separation
- Provisions & storage

NOLTE LIVING – MORE THAN JUST A KITCHEN

Increasingly, the kitchen is opening up on living space, boundaries are merging, an open-plan eat-in kitchen as the focal point of the home is now right on trend. This makes it all the more important to design the crossover into living space in the same colours and decors as you use in the kitchen. Now, nothing could be easier with Nolte LIVING. And best of all: Matrix150 leaves all furniture in exactly the same dimensions as you choose for the kitchen. Instantly conjuring a picture of lovely harmony, all on its own.



MY NOLTE LIVING CONCEPT

DISCOVER OUR HOME STORIES

Our home stories show you three different home-living concepts that have been implemented with furniture from Nolte Küchen. All three projects demonstrate individuality and inspiration in their very own way.

Discover a colourful utility room, a modern country-style kitchen and an exceptional home-living concept on Lake Königssee.



Nolte Küchen X @tinaruthe_

Tina Ruthe blogs about momlife, trends and fashion. She's gone for utility rooms in on-trend olive green. Her composition is creative, modern and doesn't go short on practical functionality, which is very important to Tina.



TO THE INTERVIEW

CLICK here



Nolte Küchen X @bobteam.johannes.lochner

Johannes Lochner is a passionate and very successful sportsman in bobsleighting. Set against a fabulous Alpine panorama, he invites us to his home on Lake Königssee and shows us how furniture from Nolte Küchen can be used to create a look that couldn't be more individual.



Nolte Küchen X @hanghaus15

Hailing from the state of Lower Austria, Julia has her dream kitchen in a country home with garden. She has gone for an interplay of design, colour and subtle details, drawing her inspiration from the Art Deco style when she planned her kitchen.





“ We don't see sustainability as a trend. For us, sustainability means treating people, the environment and nature with respect. “



Sustainability has always been an integral part of Nolte Küchen's corporate policy. Social responsibility, protecting the environment and conserving natural resources are always part of our everyday actions and thinking in an endeavour to achieve lasting improvements for mankind and nature.

OUR COMMITMENT TO...



THE COMPANY

As a matter of good corporate governance and the values that are associated with this, we have established resilient structures, processes and partnerships over a period of many years. High quality, modern aesthetic appeal and sustainability coupled with attractive value for money are criteria that are always factored into our product range. In this way, for instance, over 99 % of the wood types we use is based on the principles of sustainable wood criteria.



THE ENVIRONMENT

As a company, we have set ourselves the goal of using natural resources in a responsible and sustainable manner. Even today, our effective climate and environmental management regime lets us manufacture our products in a climate-neutral manner at our operating bases in Löhne and Melle. Nolte Küchen's main energy sources are certified green electricity as well as our boilers which are operated with offcut wood from production.



THE HUMAN ELEMENT

Our members of staff are particularly close to our heart. Their dedication, knowledge, experience and inquisitiveness are what define us as Nolte Küchen. For this reason, we are pleased to assist our staff in furthering their development – both on the work side through basic and further training as well as at a private level by respecting and enhancing their work-life balance.



THE SOCIETY

Since Nolte Küchen was founded, we have cultivated close ties with the region and play an active part in fostering its well-being and growth. We can look back on a long tradition of social commitment and have placed great emphasis on this from the very first day. For instance, we help people and regions in situations of need, e.g. educational institutions, associations, institutions and foundations that focus on protecting children. Our credo: support is given where support is needed.



PLANNING YOUR KITCHEN

FROM THE VERY BEGINNING, ALL EXACTLY TO PLAN

Before you start planning in detail, you should define the fundamental structural set-up, such as room size and layout. Important also are the exact positions of windows, doors, power sockets and connections. Once you have carefully measured everything up, make a scale drawing of your kitchen's floor plan on the adjacent planning sheet – as the basis for successfully planning a Nolte kitchen tailored exactly to meet your expectations and needs.



Start measuring up!

This page with **squared paper** gives you basis for drawing you floor plan and for entering the details.

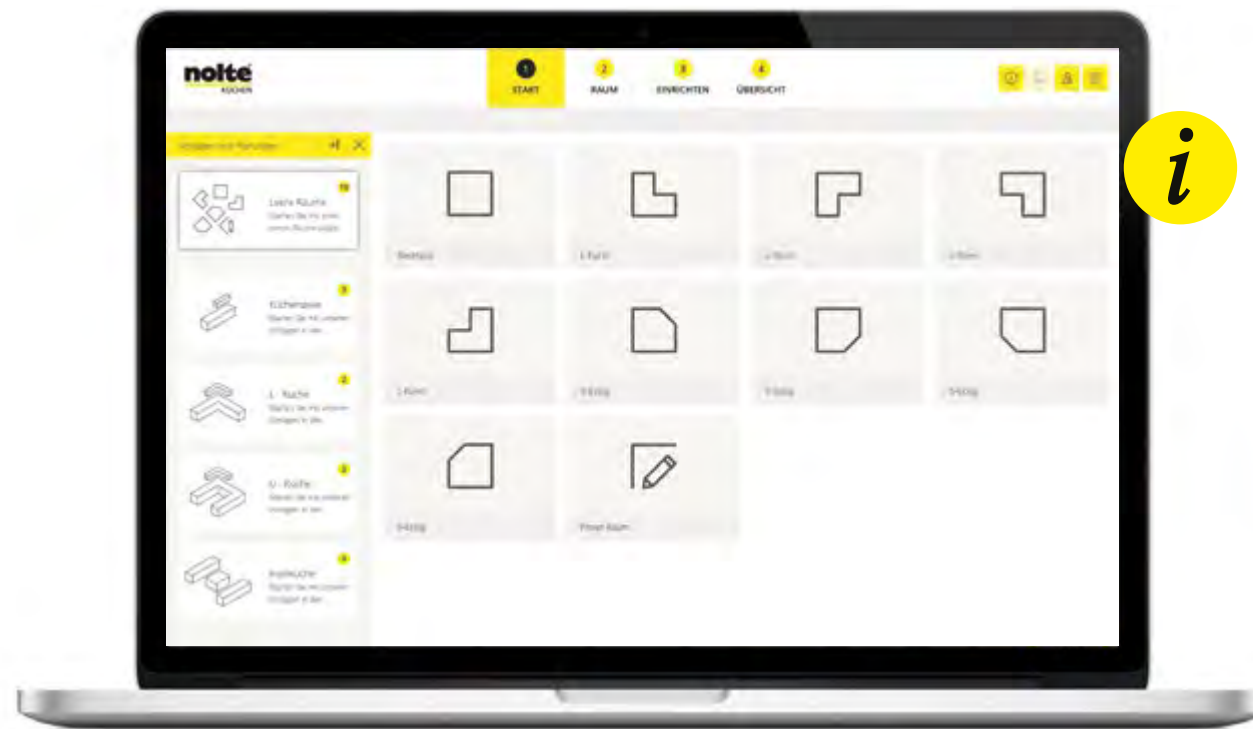
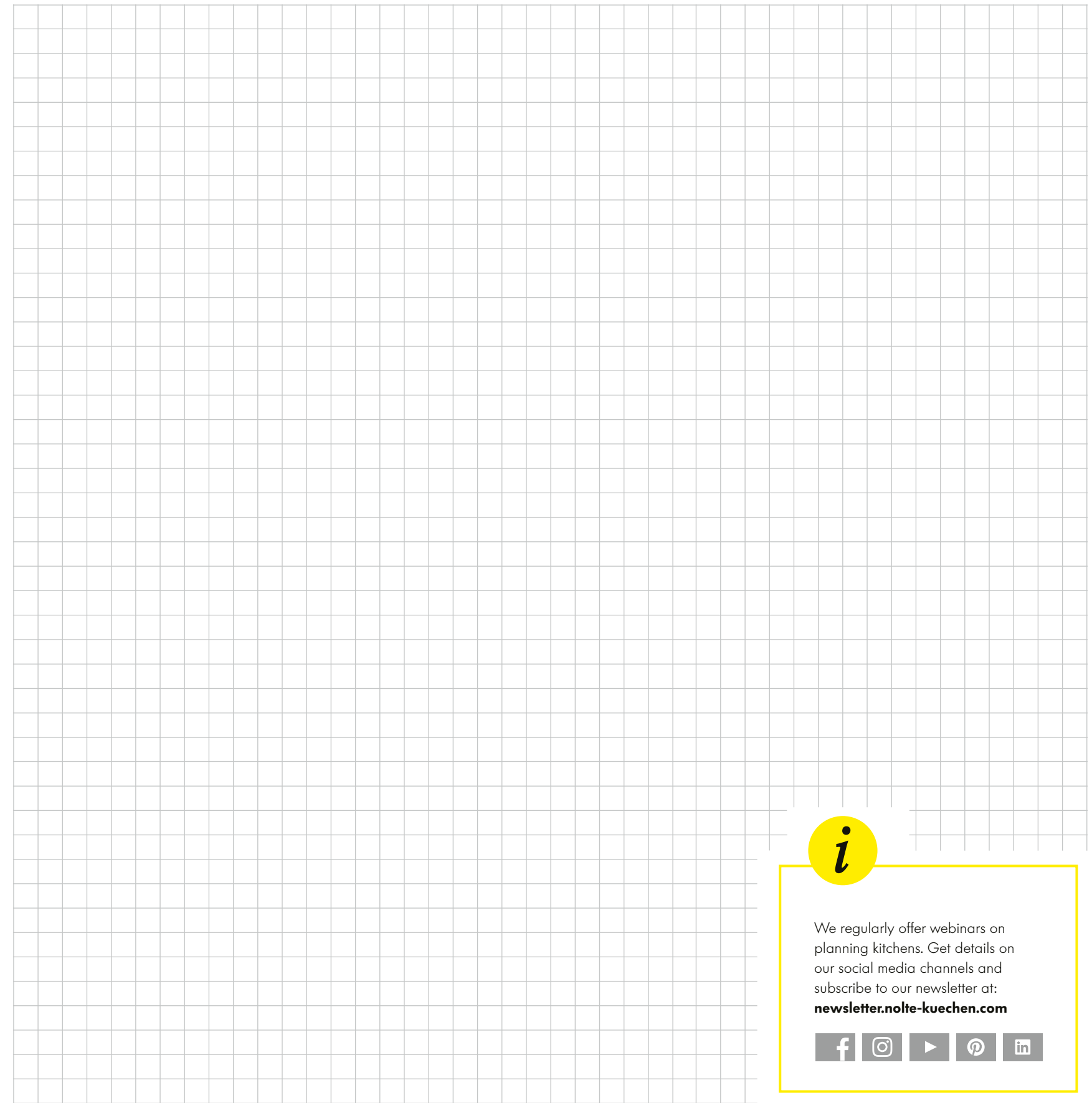

Your Nolte Küchen planner on the web:

Online, you will find lots more information on how to plan your kitchen. Click by click, you will be guided through every step of the planning process – leaving you with the best possible result!

Try it out for yourself:



We regularly offer webinars on planning kitchens. Get details on our social media channels and subscribe to our newsletter at: newsletter.nolte-kuechen.com



MY KITCHEN PROFILE



CHECK-LIST FOR TALKS WITH YOUR KITCHEN PLANNER

- 1 What situation are you living in?
 owner-occupied rented
 alteration new build
Can you or are you planning to make structural changes?
If so, which ones? _____
- 2 Do you think you are likely to move and take your kitchen with you in the next 5 years?
 yes no
Make sure you give your kitchen a modular design!
- 3 Do you want your kitchen to be a place to work or live in?
 only for cooking for cooking and dining
 as the hub of the home
- 4 How many persons will be using your kitchen?
 1-2 persons 3-4 persons 5 or more persons
- 5 How often do you cook?
 every day several times a week
 only at weekends rarely
- 6 What is your style of cooking? Usually:
 quick, easy meals
 dishes involving a lot of work
 both
- 7 Which type of environment and style do you feel at home in?
 right on trend timeless country style

- 8 Which words best describe your taste in kitchens?
This information will help the planner to give you the style of kitchen you want:
 homely practical minimalist
 structured individually styled practical
 tidy inviting large
 colourful simple classy
 rustic
Other terms: _____

- 9 Handle or no handle?
 Handle handleless

- 10 Which style-defining elements do you see in your kitchen?
 kitchen with handles handleless
 planning a sleek look planning a relaxed look
 open shelf units cooking island
 display units counter solution

- 11 Which materials / surface finishes do you prefer?
Wooden surface: real wood wood reproduction
Cement surface: real cement cement reproduction
Metal surface: real metal metal reproduction
Lacquered surface:
Genuine lacquer mat gloss
Lacquered laminate mat gloss
Laminate with anti-fingerprint finish (mat)

- 12 What do you want to spend on your new kitchen?
My kitchen budget: _____

- 13 How much space you have for your kitchen?
 up to 8 sq.m. 8-15 sq.m. 16-25 sq.m. over 25 sq.m.

- 14 Which particular structural aspects need to be considered in the room? Please make a note of this on the left-hand side of your sketch:
 room dimensions angles (if not 90°)
 door sizes left or right-hung
Where do these door lead to? _____
 window sizes sill height
 position of radiators water connection
 drain cooker connection
 power sockets for lighting midway section power sockets
 other power sockets (refrigerator / extractor hood)



Please open to start answering question 1.

MY KITCHEN PROFILE

YOUR PERSONAL NOLTE KÜCHEN CHECK-LIST FOR TALKS WITH YOUR KITCHEN PLANNER:

This is where you will find possible answers to the various questions asked on how you want to plan your kitchen profile. You can start by making a note of a few basic details you would like to include in your dream kitchen. The next page then starts by asking questions on planning it!

- 15 Are you looking for an open or an enclosed kitchen?
 separate room open-plan eat-in kitchen

- 16 Which kitchen shape do you prefer?
 single galley double galley L-shaped kitchen
 U-shaped kitchen with kitchen island with counter solution
 with dining for _____ persons no particulars

- 17 How do you normally do your shopping?
 in most cases fresh from provisions whenever necessary

- 18 Is any additional storage space available?
 pantry basement utility room

- 19 Which kitchen appliances do you need to keep on the worktop or store in a cupboard?
 toaster kettle coffee maker
 microwave oven food processor(s)
e.g. all-in-one cooking machine

- 20 How tall are the persons who regularly use the kitchen?
smallest person: _____ tallest person: _____

- 21 Which appliances need to be integrated in a way that makes them ergonomic to use?
 oven steam cooker coffee maker
 microwave oven dishwasher

- 22 Do you want to lower the worktop to give you more work surface?
 yes no

Further details for planning your kitchen:

Which appliances do you want to integrate in my kitchen?

- | | |
|--|---|
| <input type="checkbox"/> Fitted cooker with hob:
<input type="checkbox"/> Induction
<input type="checkbox"/> Electric
<input type="checkbox"/> Gas
<input type="checkbox"/> Oven
<input type="checkbox"/> Steam cooker
<input type="checkbox"/> Refrigerator
<input type="checkbox"/> Freezer | <input type="checkbox"/> Autonomous hob:
<input type="checkbox"/> Induction <input type="checkbox"/> with integrated extractor fan
<input type="checkbox"/> Electric
<input type="checkbox"/> Gas
<input type="checkbox"/> Microwave
<input type="checkbox"/> Coffee maker
<input type="checkbox"/> Combined fridge/freezer |
|--|---|

How do you want the extractor hood installed?

- | | |
|--|--|
| <input type="checkbox"/> Hob with integrated extractor fan | <input type="checkbox"/> Island extractor |
| <input type="checkbox"/> Wall-mounted hood | <input type="checkbox"/> Fitted in base unit |
| <input type="checkbox"/> Fitted in wall unit | |

- | | |
|-----------------------------------|--|
| <input type="checkbox"/> Expelled | <input type="checkbox"/> Re-circulated |
|-----------------------------------|--|

What material do you want your inset sink to be made of?

- | | |
|---|----------------------------------|
| <input type="checkbox"/> Stainless steel | <input type="checkbox"/> Ceramic |
| <input type="checkbox"/> Solid-surface material | <input type="checkbox"/> Granite |

Which sources of light do you want in your kitchen?

- | |
|---|
| <input type="checkbox"/> Downlighter shelves in wall units |
| <input type="checkbox"/> Lighting for drawers and pull-outs |
| <input type="checkbox"/> Built-in spotlights |
| <input type="checkbox"/> Built-under light fittings |
| <input type="checkbox"/> Illuminated shelves |

Would you like multimedia links in your kitchen?

- | |
|---|
| <input type="checkbox"/> Power sockets / USB |
| <input type="checkbox"/> Bluetooth / Wi-Fi sound system |

The kitchen is the room of rooms.
We probably *live* more,
and more *intensively*,
here than anywhere else in the home.
It is the place where
we meet, where we encounter others.
As family or friends.
As a couple.
We *cook*, *eat* and *enjoy* ourselves
in the kitchen. And sometimes we have
all the time in the world as we do so.
We argue. And *make up again*.
We read, write, send emails, post messages.
And maybe philosophise a little.
And – quite secretly – the kitchen sets
the rhythm of our day.
Good morning. Then midday. Then evening.
And sometimes night ...
Which is *why we love* the kitchen.

Living in the kitchen. nolte